



LES PRODUITS

GREFINO

PRODUCTS

Nous innovons votre espace extérieur.

We Innovate your Outdoor space.

Catalogue 2024



Table des matières | Table of contents

Les produits Grefino Inc. Grefino Products Inc.	1
Les avantages et les caractéristiques techniques de la porcelaine The advantages and the technical characteristics of porcelain	5
Les différentes méthodes d'installation Different installation methods	7
Collection Grefino	8
Del Conca	32
Grestone®	76
Eterno Ivica	98
MLT System™ Outils de nivelage Leveling tools	140
Alpha® Outils professionnels Professional Tools	146



LES PRODUITS

GREFINO

PRODUCTS

Nous innovons votre espace extérieur.
We Innovate your Outdoor space.





Nous innovons votre espace extérieur.
We Innovate your Outdoor space.

Les produits Grefino Inc. | Grefino Products Inc.

Fondée par une **entreprise familiale** avec plus de 30 ans d'expertise dans le domaine de l'aménagement extérieur, **Les produits Grefino Inc.** est un **fournisseur** ainsi qu'un **fabricant** de **dalles** et de **pavés** en **porcelaine** fabriqués en Italie. De la conception à la fabrication, Grefino s'est donné pour mission d'**innover votre espace de vie extérieur** en vous offrant une gamme complète de dalles et de pavés en porcelaine pour vos projets. | Founded by a **family business** with over 30 years of expertise in the outdoor landscaping field, **Grefino Products Inc.** is a **supplier** as well as a **manufacturer** of **porcelain slabs** and **pavers** made in Italy. From design to manufacture, Grefino's mission is to innovate your **outdoor living space** by offering a complete range of porcelain slabs and pavers for your projects.

Nos marques | Our brands



Restons en contact ! | Let's stay in touch!

Visitez notre site web au www.produitsgrefino.com | Visit our website at www.grefinoproducts.com

Écrivez-nous à info@grefino.ca | Write to us at info@grefino.ca

Appelez-nous au **450 323-0260** | Call us at **450 323-0260**

Suivez-nous sur nos **médias sociaux** | Follow us on our **social media**



Les avantages de la porcelaine

- Ne raye pas et ne se tache pas
- Ne change pas de couleur avec le temps
- Ne nécessite aucun entretien
- Résiste au sel de déglçage, à l'acide et aux produits de nettoyage chimiques
- Résiste aux cycles de gel-dégel
- Antidérapante
- Facile à nettoyer
- Hautement résistante aux charges
- Sans efflorescence

The advantages of porcelain

- Does not scratch or stain
- Colours do not fade over time
- Requires no maintenance
- Resistant to de-icing salt, acid and chemical cleaning products
- Resistant to freeze-thaw cycles
- Anti-slip
- Easy to clean
- Highly resistant to loads
- No efflorescence

Les caractéristiques techniques de la porcelaine

Technical characteristics of porcelain

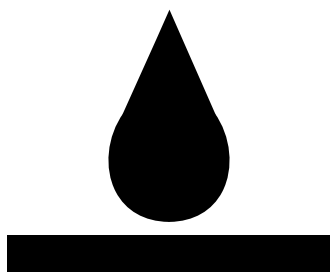

Absorption d'eau
Water Absorption

$E \leq 0,5 \%$

EN ISO 10545-3

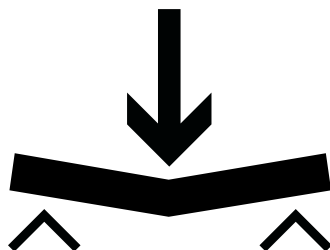

Résistance à la flexion
Bending strength

EN ISO 10545-4

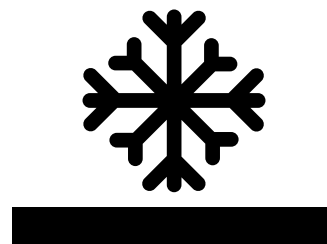

Résistance au gel
Frost resistance

EN ISO 10545-12



Résistance au glissement
Skid resistance

R11 - EN 16165, Annexe B
C - EN 16165, Annexe A

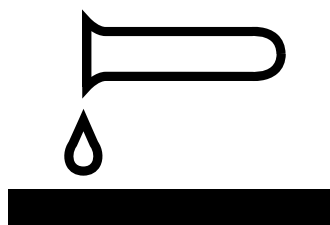

Résistance aux produits chimiques
Chemical resistance

EN ISO 10545-13

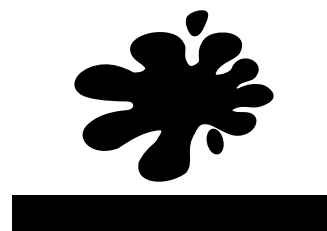

Résistance aux taches
Stain resistance

EN ISO 10545-14



Installation collée sur béton avec un mortier adhésif | Glued to concrete with adhesive mortar
Dalle | Slab Quartz-2 Beige

Les différentes méthodes d'installation

Different installation methods



**Installation surélevée sur
plots réglables Eterno Ivica**
**Raised on Eterno Ivica
adjustable pedestals**

Installation sur un lit de pierre nette 1/8
Laid on a bed of 1/8 clean stone



Avec l'écarteur mini DM
sans embout
With Mini DM Spacer
without aglet

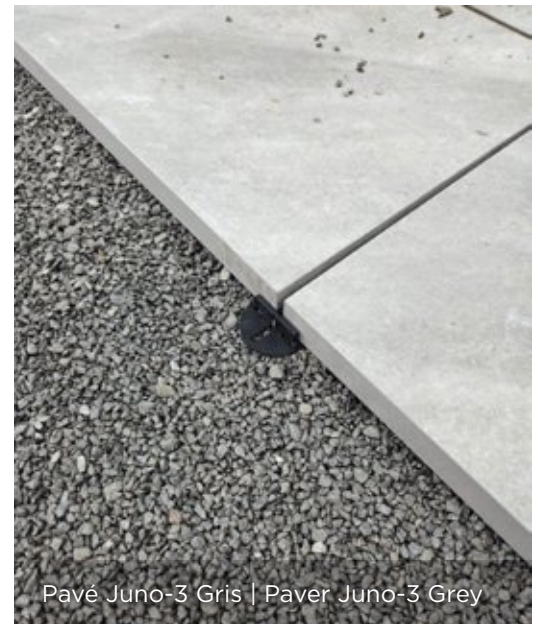

**Installation collée sur béton
avec un mortier adhésif**
**Glued to concrete
with adhesive mortar**



**Scannez-moi pour visionner
les étapes de l'installation !**



**Scan me to view
installation steps!**





Toit-terrace | Rooftop terrace
Hyatt Centric, Montréal | Hyatt Centric, Montreal
Dalle Quartz-2 Noir | Slab Quartz-2 Black



COLLECTION
GREFINO



Toit-terrasse | Rooftop terrace
Hyatt Centric, Montréal | Hyatt Centric, Montreal
Dalle Quartz-2 Noir | Slab Quartz-2 Black

Dalles de porcelaine | Porcelain slabs - 2 cm

Avec leurs finitions esthétiques et leur extrême résistance à l'usure piétonne, les dalles de porcelaine de **2 cm** de la Collection Grefino sont l'idéal pour les **toits-terrasses** ainsi que les **recouvrements de balcons et d'escaliers**. | With their aesthetic finish and extreme resistance to pedestrian wear, **2 cm** porcelain slabs from the Grefino Collection are ideal for **rooftop terraces** as well as for **cladding of balconies and staircases**.



Dalle | Slab Quartz-2 Beige



Dalle Quartz-2 Gris | Slab Quartz-2 Grey

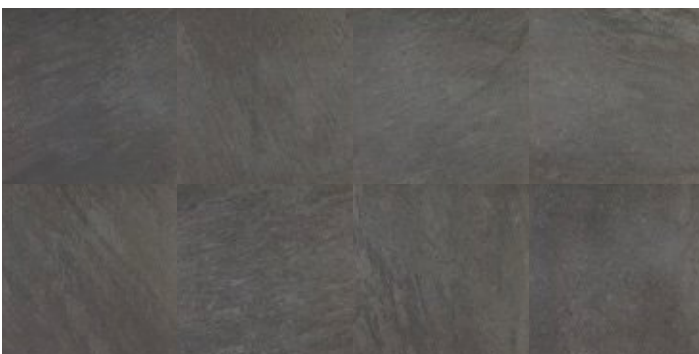

Dalle Quartz-2 Noir | Slab Quartz-2 Black



Recouvrement de balcon et d'escalier | Cladding of balcony and staircase
Dalle Quartz-2 Gris | Slab Quartz-2 Grey

Dalles | Slabs Quartz

Couleurs disponibles | Available colours



Beige

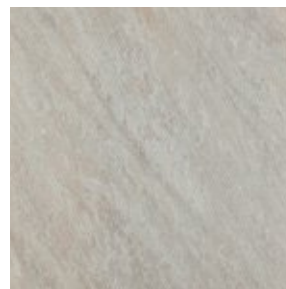
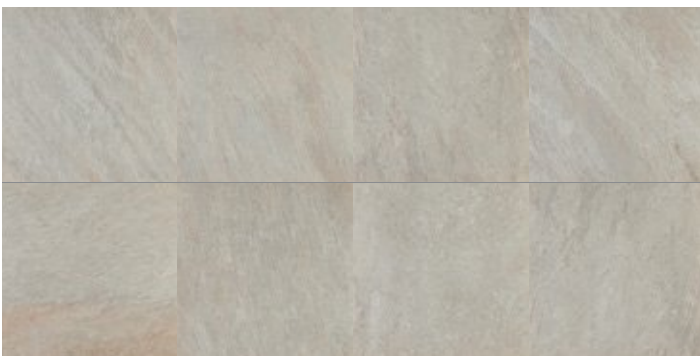

Gris | Grey

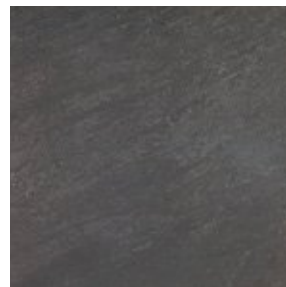
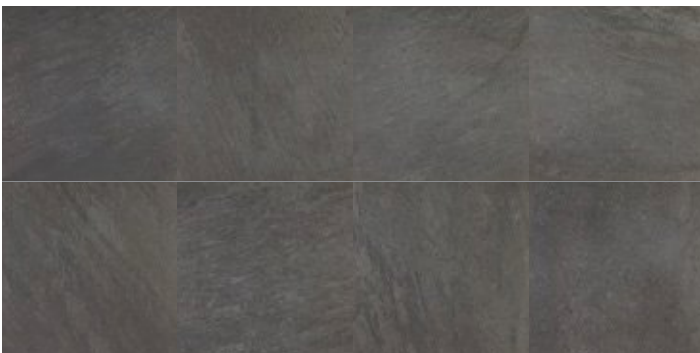

Noir | Black

Dimension disponible | Available dimension

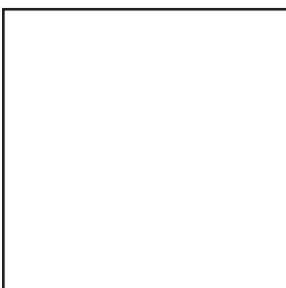

60 x 60 x 2 cm
24" x 24" x 3/4"



Allée de maison | Driveway
Pavé Lavica-3 Gris | Paver Lavica-3 Grey

Pavés en porcelaine | Porcelain pavers - 3 cm

Grâce à leur épaisseur de **3 cm**, les pavés en porcelaine de la Collection Grefino sont extrêmement résistants aux charges lourdes et sont conçus pour les **allées de maisons**, les **stationnements**, les **patios**, les **terrasses** ainsi que les **espaces urbains**. | Thanks to their **3 cm** thickness, the porcelain pavers from the Grefino Collection are extremely resistant to heavy loads and are made for **driveways**, **parking areas**, **patios**, **terraces** as well as **urban spaces**.



Pavé Toscan-3 Blanc | Paver Toscan-3 White



Pavé | Paver Riviera-3 Beige

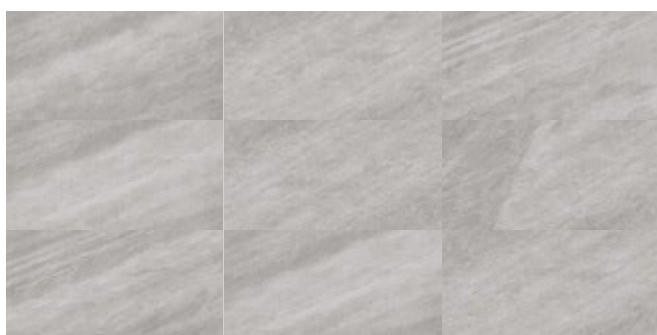

Pavé Juno-3 Gris | Paver Juno-3 Grey



Pavé Lavica-3 Gris | Paver Lavica-3 Grey



Pavé Climb-3 Gris | Paver Climb-3 Grey



Patio et terrasse | Patio and terrace
Pavé Toscan-3 Blanc | Paver Toscan-3 White

Pavé | Paver Toscan

Couleur disponible | Available colour



Blanc | White

Dimension disponible | Available dimension

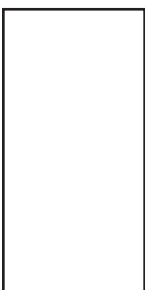

40 x 80 x 3 cm
16" x 32" x 1 ¼"



Allée et stationnement | Driveway and Parking area
Pavé | Paver Riviera-3 Beige

Pavé | Paver Riviera

Couleur disponible | Available colour



Beige

Dimension disponible | Available dimension

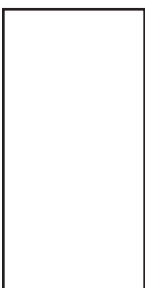

40 x 80 x 3 cm
16" x 32" x 1 ¼"



Allée et stationnement | Driveway and Parking area
Pavé Juno-3 Gris | Paver Juno-3 Grey

Pavé | Paver Juno

Couleur disponible | Available colour



Gris | Grey

Dimension disponible | Available dimension

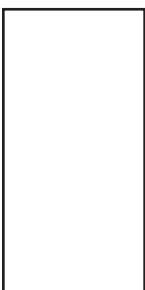

40 x 80 x 3 cm
16" x 32" x 1 ¼"



Pavé | Paver Lavica

Couleur disponible | Available colour



Gris | Grey

Dimension disponible | Available dimension

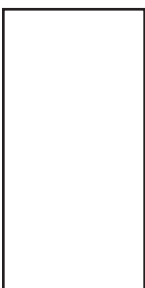

40 x 80 x 3 cm
16" x 32" x 1 ¼"



Patio et terrasse | Patio and terrace
Pavé Climb-3 Gris | Paver Climb-3 Grey

Pavé | Paver Climb

Couleur disponible | Available colour



Gris | Grey

Dimension disponible | Available dimension

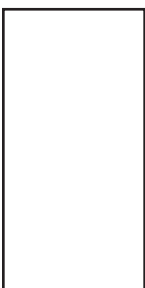

40 x 80 x 3 cm
16" x 32" x 1 ¼"

Inspirations

Recouvrements de balcons et d'escaliers

Cladding of balconies and staircases



Dalle | Slab Quartz-2 Beige



Dalle Quartz-2 Gris | Slab Quartz-2 Grey

Inspirations

Patios et terrasses | Patios and Terraces



Dalle | Slab Quartz-2 Beige

Inspirations

Patios et terrasses | Patios and Terraces



Dalle Quartz-2 Noir | Slab Quartz-2 Black

Inspirations

Patios et terrasses | Patios and Terraces



Pavé Juno-3 Gris | Paver Juno-3 Grey

Inspirations

Allée et stationnement | Driveway and Parking area



Inspirations

Espace urbain | Urban space



Pavé Climb-3 Gris | Paver Climb-3 Grey







Toit-terrasse | Rooftop Terrace
Dalle HWD 205 Gris | Slab HWD 205 Grey

Dalles de porcelaine | Porcelain slabs - 2 cm

Forte de plus de 10 ans d'expérience sur les chantiers du monde entier, la gamme **due2** s'enrichit constamment pour répondre à toutes les exigences conceptuelles d'espaces extérieurs privés et publics. Autant pour les **allées piétonnes**, les **toits-terrasses**, les **patios**, les **piscines** et les **terrasses**. | With over 10 years' experience on construction sites all over the world, the **due2** range is constantly being expanded to meet all design requirements for private and public outdoor spaces. For **walkways**, **rooftop terraces**, **patios**, **swimming pools** and **terraces**.

Effet pierre
Stone effect



Effet bois
Wood effect



Effet béton
Concrete effect



Effet terre cuite
Terracotta effect





Dalles | Slabs Nesting 2_HNS2

Effet pierre | Stone effect

Couleurs disponibles | Available colours

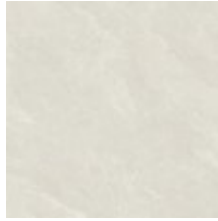

HNS 210
Blanc | White

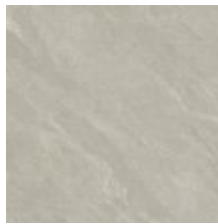

HNS 201
Amande | Almond

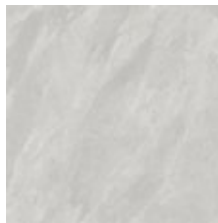
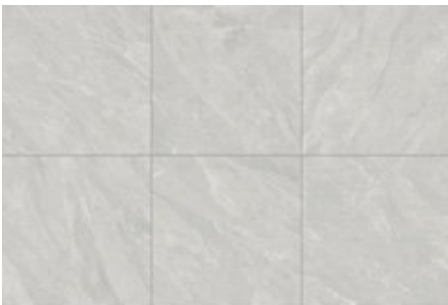

HNS 215
Glacier | Iceberg



HNS 205
Gris | Grey



HNS 208
Anthracite

Dimension disponible | Available dimension

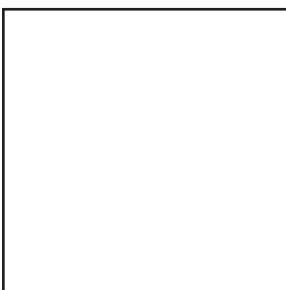

80 x 80 x 2 cm
32" x 32" x 3/4"



Dalles | Slabs Wild 2_HWD2

Effet pierre | Stone effect

Couleurs disponibles | Available colours



HWD 210
Blanc | White



HWD 205
Gris | Grey



HWD 211
Grège | Greige



HWD 201
Beige

Dimension disponible | Available dimension

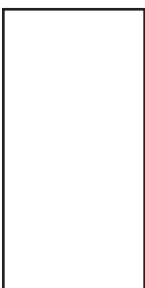

60 x 120 x 2 cm
24" x 48" x 3/4"



Patio et terrasse | Patio and Terrace
Dalle HLA 210 Blanc | Slab HLA 210 White

Dalles | Slabs Lavaredo 2_HLA2

Effet pierre | Stone effect

Couleurs disponibles | Available colours



HLA 210
Blanc | White



HLA 201
Beige



HLA 203
Naturel | Natural



HLA 205
Gris | Grey

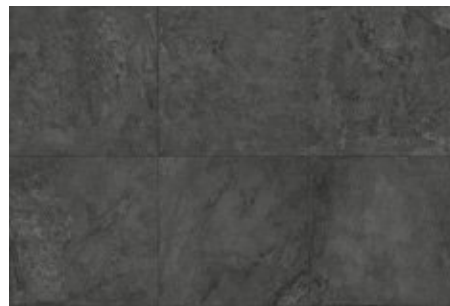

HLA 208
Anthracite

Dimensions disponibles | Available dimensions

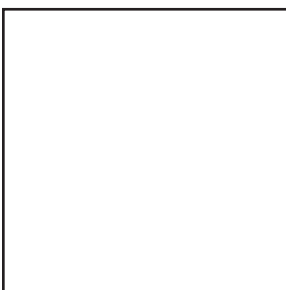

120 x 120 x 2 cm
48" x 48" x 3/4"

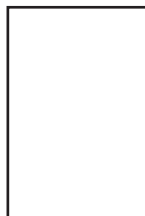

60 x 90 x 2 cm
24" x 36" x 3/4"



60 x 60 x 2 cm
24" x 24" x 3/4"



Dalles | Slabs Soul 2_HSU2

Effet pierre | Stone effect

Couleurs disponibles | Available colours



HSU 201
Beige

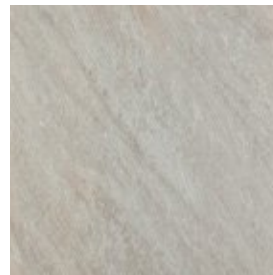
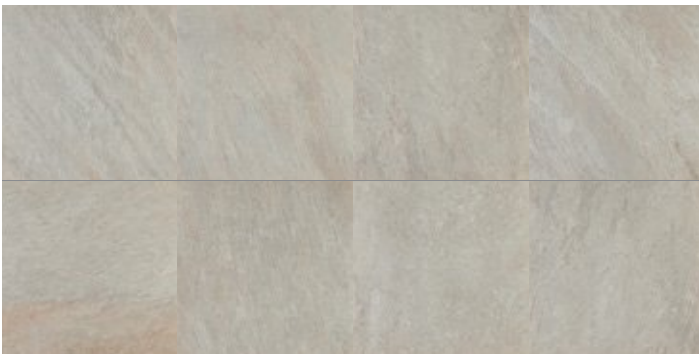

HSU 205
Gris | Grey

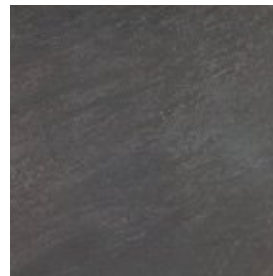
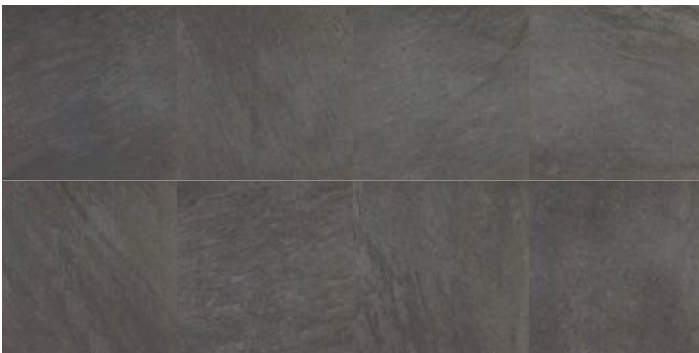

HSU 208
Noir | Black

Dimension disponible | Available dimension

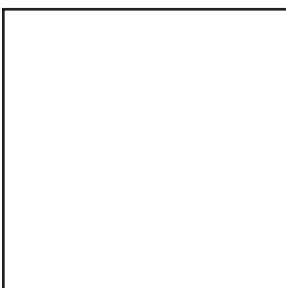

60 x 60 x 2 cm
24" x 24" x 3/4"



Dalles | Slabs Engadina 2_HEG2

Effet pierre | Stone effect

Couleurs disponibles | Available colours

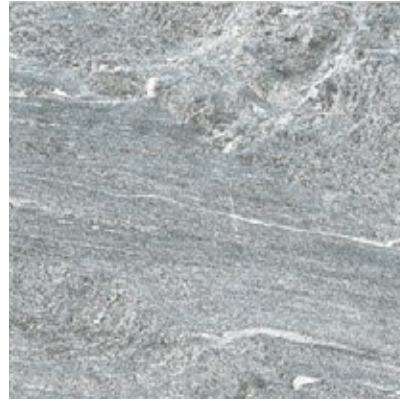

HEG 205
Gris | Grey

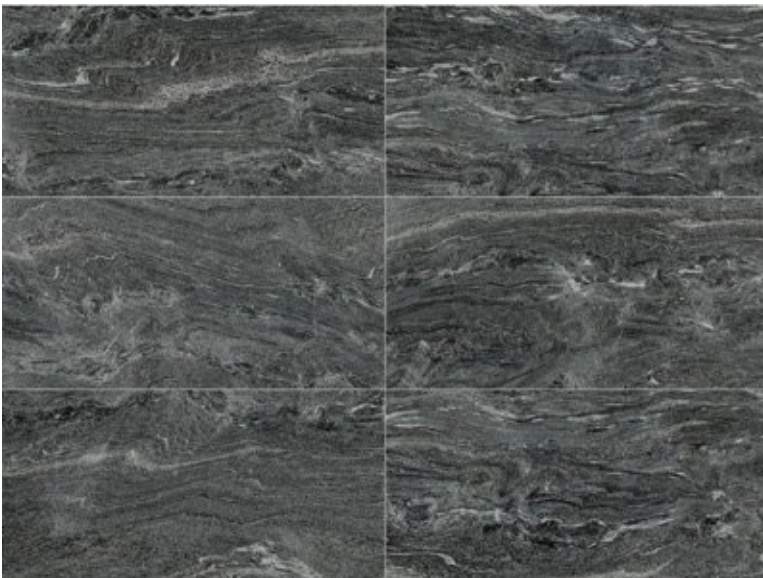

HEG 208
Noir | Black

Dimensions disponibles | Available dimensions

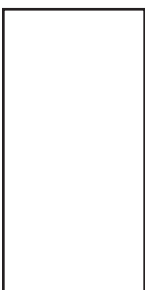

60 x 120 x 2 cm
24" x 48" x 3/4"



40 x 80 x 2 cm
16" x 32" x 3/4"



Dalles | Slabs Blue Quarry 2_HBQ2

Effet pierre | Stone effect

Couleurs disponibles | Available colours



HBQ 205
Gris | Grey

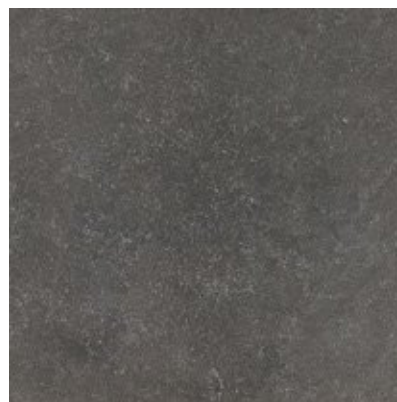
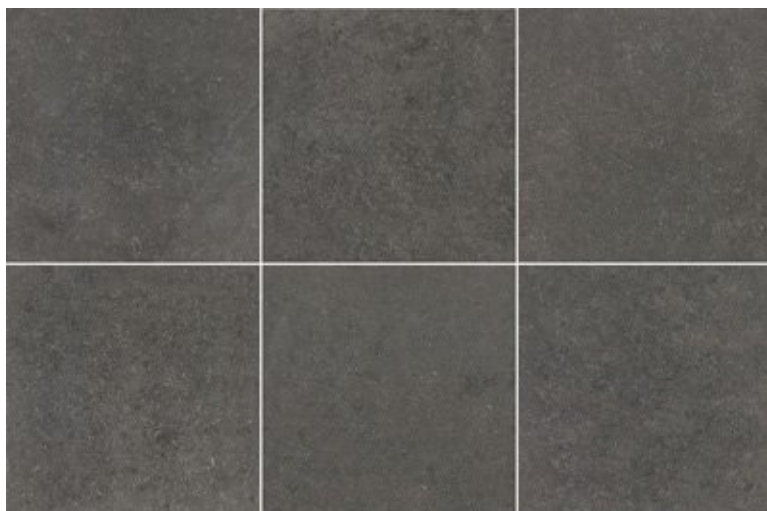

HBQ 208
Noir | Black

Dimension disponible | Available dimension

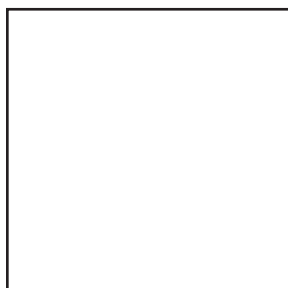

60 x 60 x 2 cm
24" x 24" x 3/4"



Dalles | Slabs Anversa 2_HAV2

Effet pierre | Stone effect

Couleurs disponibles | Available colours



HAV 201
Gris clair | Light Grey

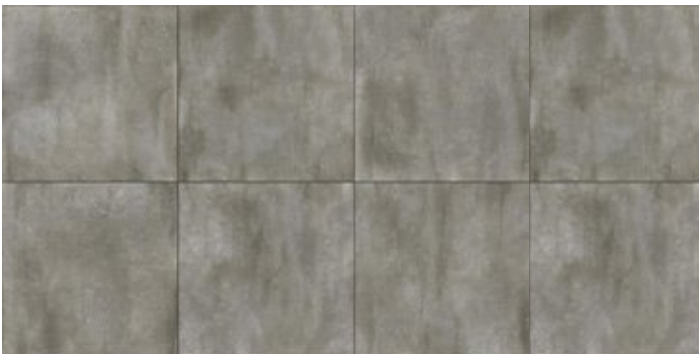

HAV 209
Tourterelle | Turtle Dove



HAV 205
Gris | Grey

Dimension disponible | Available dimension

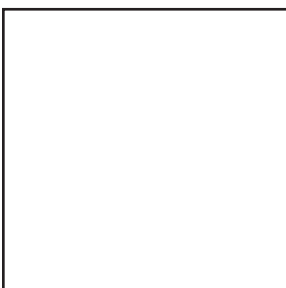

120 x 120 x 2 cm
48" x 48" x 3/4"



Dalles | Slabs Trevi 2_HTE2

Effet pierre | Stone effect

Couleurs disponibles | Available colours



HTE 201
Beige



HTE 205
Gris | Grey

Dimension disponible | Available dimension

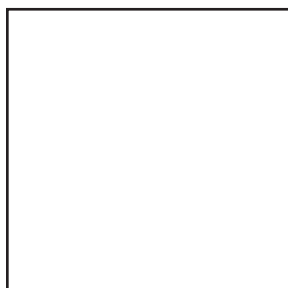

60 x 60 x 2 cm
24" x 24" x 3/4"



Patio et terrasse | Patio and Terrace
Dalle HFR 205 Gris | Slab HFR 205 Grey

Dalles | Slabs Forum 2_HFR2

Effet pierre | Stone effect

Couleurs disponibles | Available colours



HFR 201 Beige



HFR 205 Gris | Grey



HFR 208 Noir | Black

Dimension disponible | Available dimension

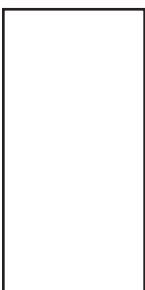

40 x 80 x 2 cm

16" x 32" x 3/4"

Produit non calibré. Un joint d'au moins 5 mm est recommandé.
Product not calibrated. A 5 mm minimum joint is recommended.



Dalle | Slab Quartz 2_HQZ2

Effet pierre | Stone effect

Couleur disponible | Available colour



HQZ 205
Gris | Grey

Dimension disponible | Available dimension

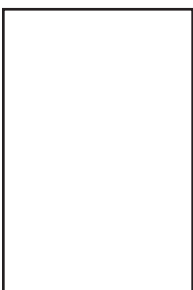

60 x 90 x 2 cm
24" x 36" x 3/4"



Patio et terrasse | Patio and Terrace
Dalle HNB 209 Brun | Slab HNB 209 Brown

Dalles | Slabs Nabi 2_HNB2

Effet bois | Wood effect

Couleurs disponibles | Available colours



HNB 205
Neutre | Neutral



HNB 210
Naturel | Natural

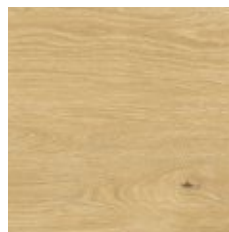

HNB 207
Miel | Honey

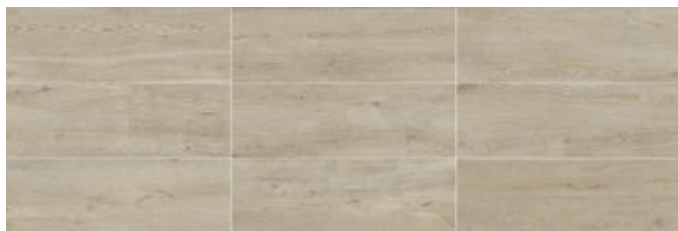

HNB 203
Taupe

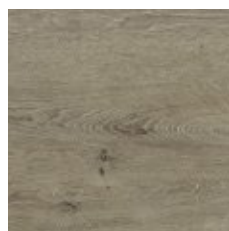

HNB 209
Brun | Brown

Dimension disponible | Available dimension



40 x 120 x 2 cm
16" x 48" x 3/4"



Dalles | Slabs Monteverde 2_HMN2

Effet bois | Wood effect

Couleurs disponibles | Available colours



HMN 201
Beige



HMN 205
Gris | Grey



HMN 209
Noyer | Walnut

Dimension disponible | Available dimension



40 x 120 x 2 cm
16" x 48" x 3/4"



Dalles | Slabs Da Vinci 2_HDV2

Effet bois | Wood effect

Couleurs disponibles | Available colours



HDV 205
Gris | Grey



HDV 209
Noyer | Walnut

Dimension disponible | Available dimension

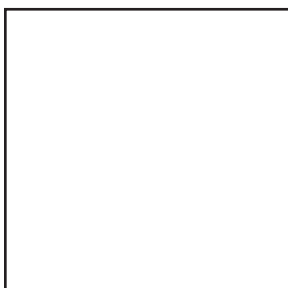

60 x 60 x 2 cm
24" x 24" x 3/4"



Dalles | Slabs Timeline 2_HTL2

Effet béton | Concrete effect

Couleurs disponibles | Available colours



HTL 210
Blanc | White



HTL 211
Beige



HTL 209
Taupe

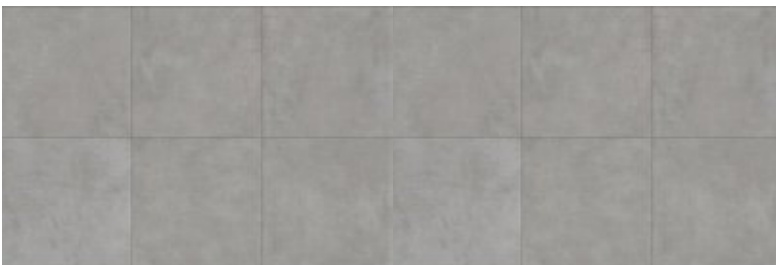

HTL 205
Gris | Grey

Dimensions disponibles | Available dimensions

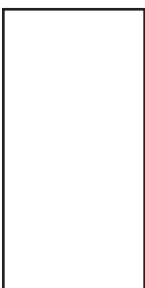

60 x 120 x 2 cm
24" x 48" x $\frac{3}{4}$ "



60 x 60 x 2 cm
24" x 24" x $\frac{3}{4}$ "



Patio et terrasse | Patio and Terrace
Dalle HUP 205 Gris | Slab HUP 205 Grey

Dalles | Slabs Upgrade 2_HUP2

Effet béton | Concrete effect

Couleurs disponibles | Available colours



HUP 205
Gris | Grey



HUP 209
Brun | Brown



HUP 215
Charbon | Charcoal

Dimension disponible | Available dimension

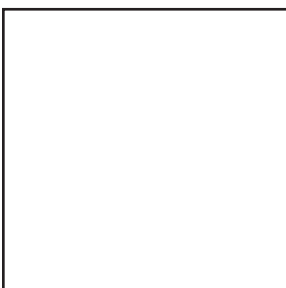

80 x 80 x 2 cm
32" x 32" x 3/4"



Patio et terrasse | Patio and Terrace
Dalle HDG 215 Charbon clair | Slab HDG 215 Light Charcoal

Dalles | Slabs Dogma 2_HDG2

Effet béton | Concrete effect

Couleurs disponibles | Available colours



HDG 201
Crème | Cream

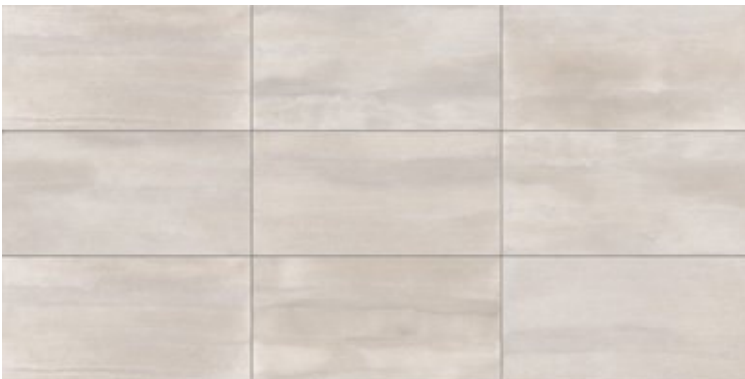

HDG 205
Grège | Greige



HDG 215
Charbon clair | Light Charcoal

Dimension disponible | Available dimension

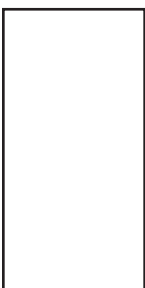

60 x 120 x 2 cm
24" x 48" x 3/4"



Patio et terrasse | Patio and Terrace
Dalle HVG 210 Blanc | Slab HVG 210 White

Dalles | Slabs Vignoni 2_HVG2

Effet terre cuite | Terracotta effect

Couleurs disponibles | Available colours



HVG 210
Blanc | White



HVG 211
Terre cuite | Terracotta



HVG 209
Noyer | Walnut

Dimensions disponibles | Available dimensions

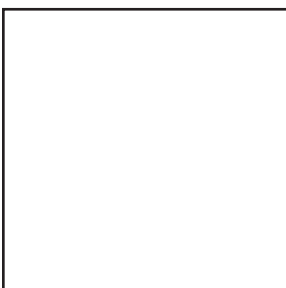

60 x 60 x 2 cm
24" x 24" x 3/4"

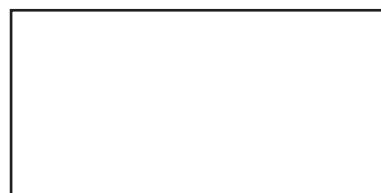

40 x 80 x 2 cm
16" x 32" x 3/4"

Inspirations

Recouvrements de balcons et d'escaliers

Cladding of balconies and staircases



Dalle HDG 205 Grège | Slab HDG 205 Greige



Dalle HEG 208 Noir | Slab HEG 208 Black

Inspirations

Recouvrements de balcons et d'escaliers Cladding of balconies and staircases



Dalle HUP 205 Gris | Slab HUP 205 Grey

Inspirations

Patios et terrasses | Patios and Terraces



Dalle HDG 215 Charbon clair | Slab HDG 215 Light Charcoal



Dalle HEG 205 Gris | Slab HEG 205 Grey

Inspirations

Patios et terrasses | Patios and Terraces



Dalle HEG 205 Gris | Slab HEG 205 Grey

Inspirations

Patios et terrasses | Patios and Terraces



Le Mount Stephen, Montréal | Le Mount Stephen, Montreal
Dalle HEG 208 Noir | Slab HEG 208 Black

Inspirations

Toits-terrasses | Rooftop Terraces



Dalle I Slab HMN 201 Beige



Dalle HDG 205 Grège | Slab HDG 205 Greige



Espace urbain | Urban space
Pavé Lapis Noir | Paver Lapis Black

G R E S T  N E[®]

V R B A N P A V I N G S



Pavés en porcelaine | Porcelain pavers - 3 et/and 5 cm

Les surfaces en grès cérame Grestone[®] Urban Pavings, d'une épaisseur de **3 et 5 cm**, se distinguent par leur extrême résistance aux charges de rupture. Une solution pour le pavage extérieur à haute valeur ajoutée comme les **espaces urbains** ainsi que les **allées** et **stationnements**. | Grestone[®] Urban Pavings porcelain stoneware surfaces, **3 and 5 cm** thick, are distinguished by their extreme resistance to breaking loads. A solution for high-value-added outdoor paving applications such as **urban spaces**, **driveways** and **parking areas**.

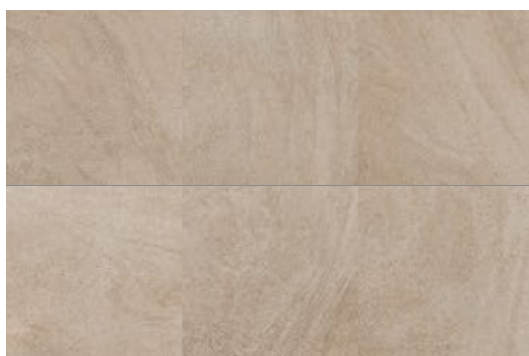

Pavé Pietra Lavica Sable
Paver Pietra Lavica Sand



Pavé Pietra Lavica Gris
Paver Pietra Lavica Grey

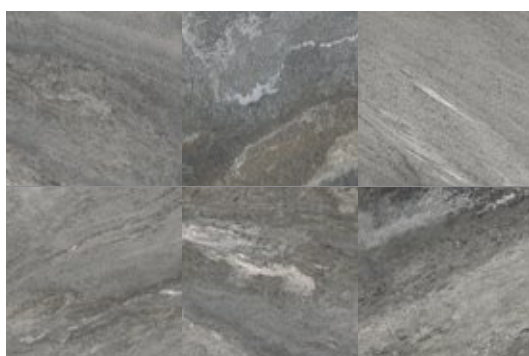

Pavé | Paver Pietra del Tirolo

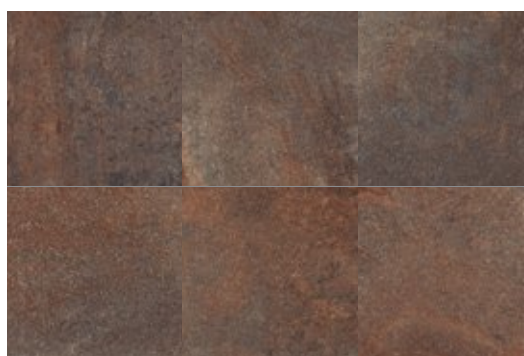

Pavé | Paver Porfido rosso

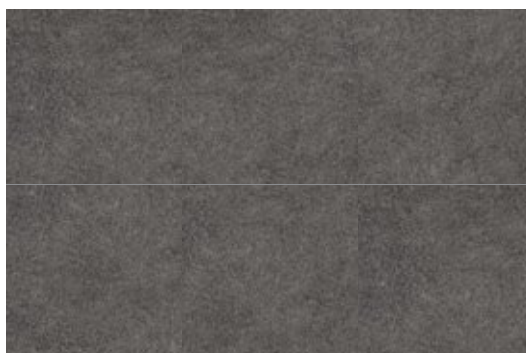

Pavé | Paver Basalto naturale



Système d'écarteurs intelligent

Smart Spacer System

Conçu pour **réduire les temps de pose** dans les grands contextes urbains, il est également idéal pour les espaces résidentiels. Le **Système d'écarteurs intelligent** inclut dans le corps des pavés détermine le joint minimum à adopter. | Designed to **reduce laying times** in large urban contexts, it is also ideal for residential spaces. **Smart Spacer System** included in the body of the pavers determines the minimum joint to be adopted.

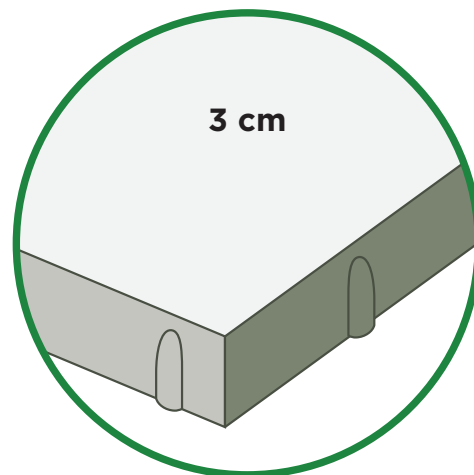
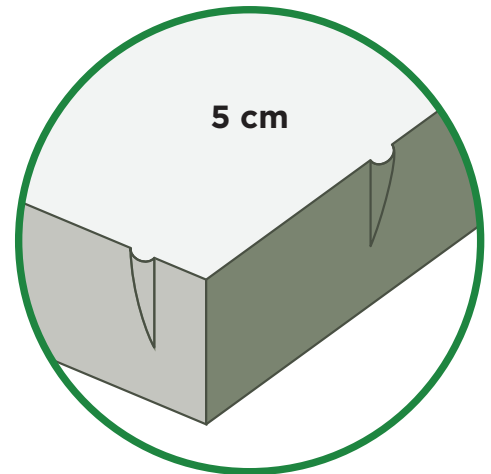
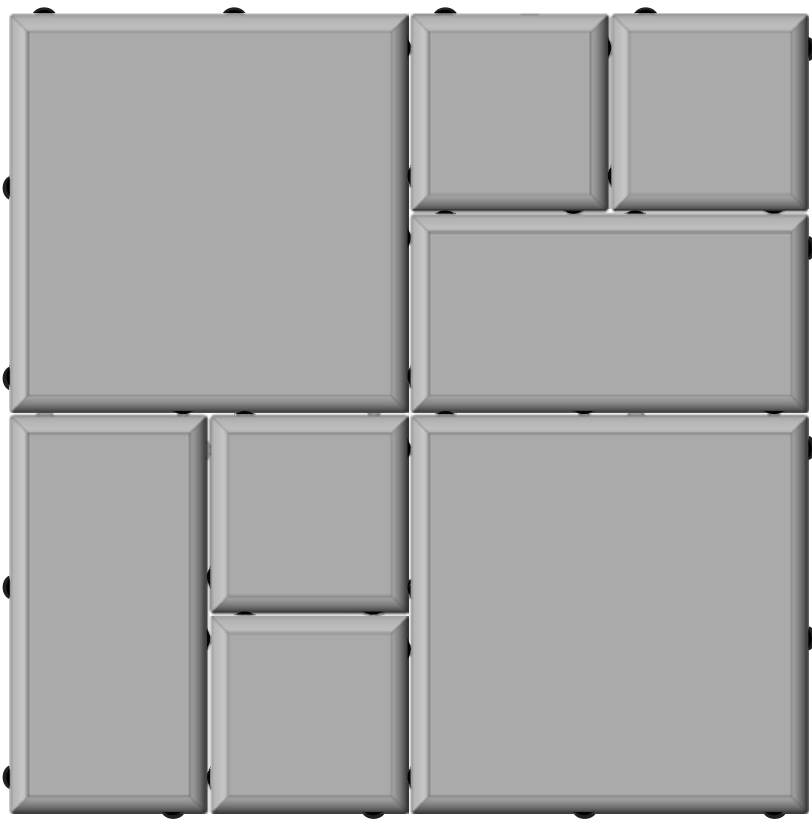



Pavés | Pavers Pietra Lavica

Couleurs disponibles | Available colours



Sable | Sand



Gris | Grey

Dimensions disponibles | Available dimensions

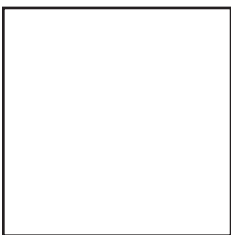

90 x 90 x 3 cm
36" x 36" x 1 1/4"

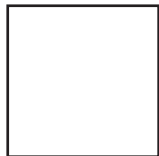

60 x 60 x 3 cm
24" x 24" x 1 1/4"



15 x 30 x 3 cm
6" x 12" x 1 1/4"

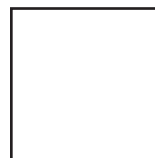

60 x 60 x 5 cm
24" x 24" x 2"



40 x 60 x 5 cm
16" x 24" x 2"



20 x 40 x 5 cm
8" x 16" x 2"

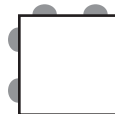

20 x 20 x 5 cm
8" x 8" x 2"



10 x 20 x 5 cm
4" x 8" x 2"



10 x 10 x 5 cm
4" x 4" x 2"



Allée et stationnement | Driveway and Parking area
Pavé | Paver Pietra del Tirolo

Pavé | Paver Pietra del Tirolo

Couleur disponible | Available colour

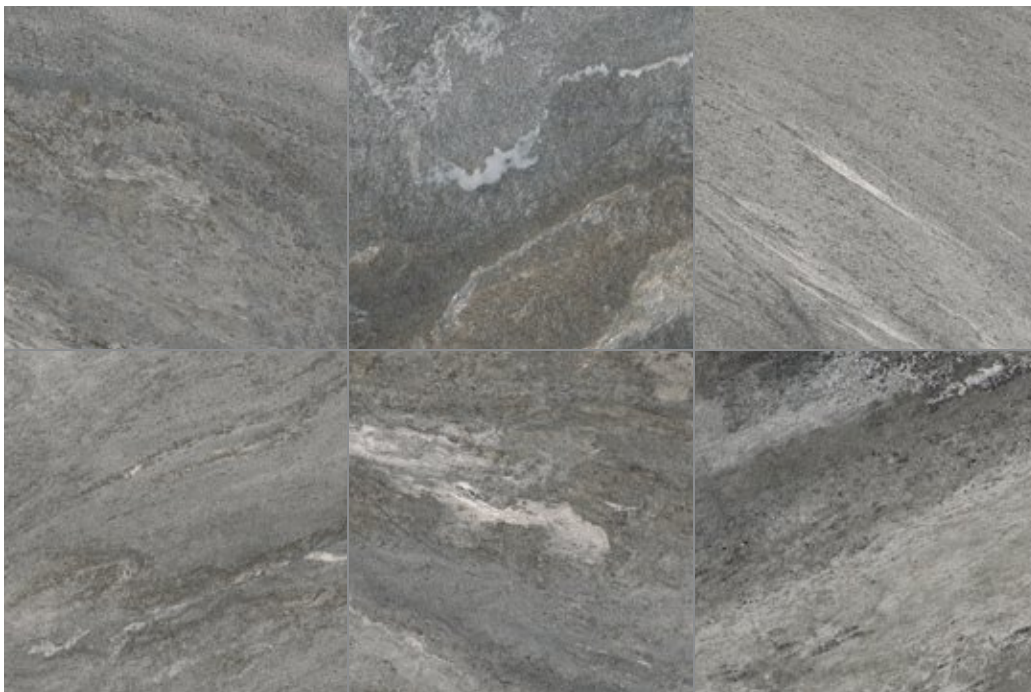

Pietra del Tirolo

Dimensions disponibles | Available dimensions

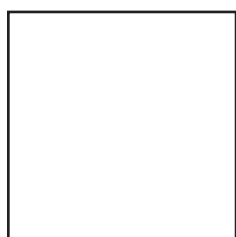

90 x 90 x 3 cm
36" x 36" x 1 1/4"

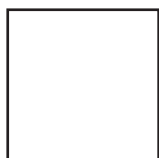

60 x 60 x 3 cm
24" x 24" x 1 1/4"



15 x 30 x 3 cm
6" x 12" x 1 1/4"



60 x 60 x 5 cm
24" x 24" x 2"

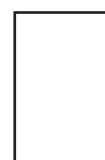

40 x 60 x 5 cm
16" x 24" x 2"



20 x 40 x 5 cm
8" x 16" x 2"

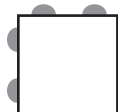

20 x 20 x 5 cm
8" x 8" x 2"



10 x 20 x 5 cm
4" x 8" x 2"



10 x 10 x 5 cm
4" x 4" x 2"



Pavé | Paver Porfido rosso

Couleur disponible | Available colour

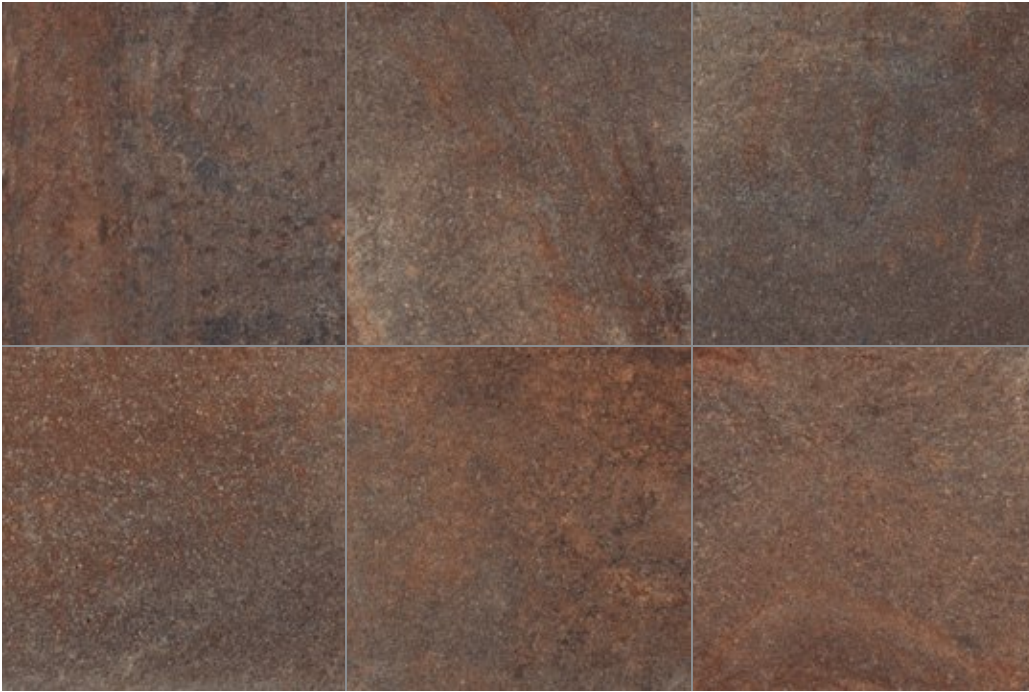

Porfido rosso

Dimensions disponibles | Available dimensions

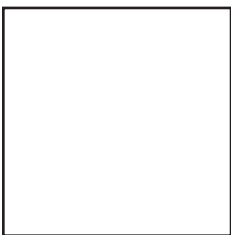

90 x 90 x 3 cm
36" x 36" x 1 1/4"

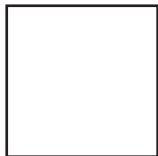

60 x 60 x 3 cm
24" x 24" x 1 1/4"



15 x 30 x 3 cm
6" x 12" x 1 1/4"



60 x 60 x 5 cm
24" x 24" x 2"

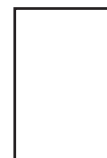

40 x 60 x 5 cm
16" x 24" x 2"



20 x 40 x 5 cm
8" x 16" x 2"

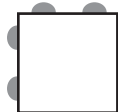

20 x 20 x 5 cm
8" x 8" x 2"



10 x 20 x 5 cm
4" x 8" x 2"



10 x 10 x 5 cm
4" x 4" x 2"



Pavé | Paver Basalto naturelle

Couleur disponible | Available colour

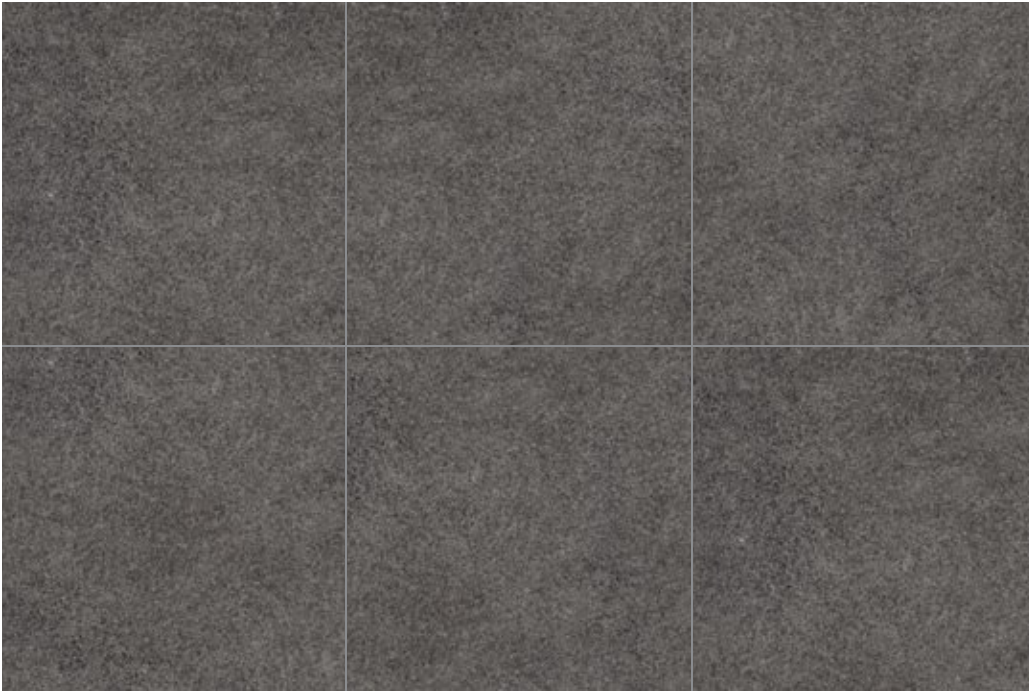

Basalto naturelle

Dimensions disponibles | Available dimensions

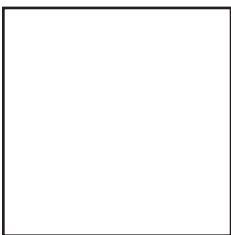

90 x 90 x 3 cm
36" x 36" x 1 1/4"

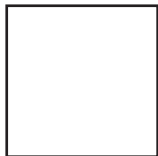

60 x 60 x 3 cm
24" x 24" x 1 1/4"



15 x 30 x 3 cm
6" x 12" x 1 1/4"



60 x 60 x 5 cm
24" x 24" x 2"

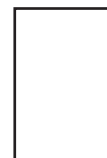

40 x 60 x 5 cm
16" x 24" x 2"



20 x 40 x 5 cm
8" x 16" x 2"

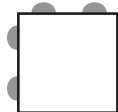

20 x 20 x 5 cm
8" x 8" x 2"



10 x 20 x 5 cm
4" x 8" x 2"



10 x 10 x 5 cm
4" x 4" x 2"



Allée et stationnement | Driveway and Parking area
Pavés Lapis Lux Gris, Noir, Blanc, Jaune et Bleu
Pavers Lapis Lux Grey, Black, White, Yellow and Blue

Pavés en porcelaine | Porcelain pavers - 6,5 cm

La **collection Lapis** est fabriquée avec une technologie de double chargement en épaisseur **6,5 cm** pour répondre aux besoins des **marquages routiers** et pour résister aux exigences les plus extrêmes dans les contextes urbains. Elle est adaptée aux **boulevards**, **places** et **allées** soumis à une circulation routière intense et prolongée, ainsi qu'aux **pistes cyclables**, aux **passages** et aux **allées pour piétons**. Résistance, polyvalence, style et fonctionnalité au service des villes contemporaines. | The Lapis collection is produced with double loaded in **6.5 cm** thickness to meet the needs of **road markings** and to withstand the most extreme demands in urban contexts. It is suitable for **boulevards**, **squares** and **alleys** subject to heavy and prolonged vehicular traffic, as well as **bicycles** and **crosswalks** and **walkways**. Resistance, versatility, style and functionality for contemporary cities.

Couleurs disponibles | Available colours



Lapis Lux Gris | Grey



Lapis Noir | Black



Lapis Blanc | White



Lapis Jaune | Yellow

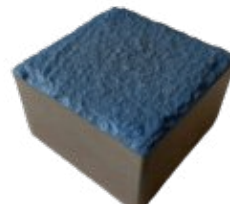
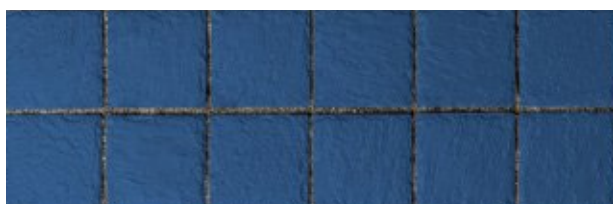

Lapis Bleu | Blue



Allée et stationnement | Driveway and Parking area
Pavés Lapis Lux Gris et Noir | Pavers Lapis Lux Grey and Black

Pavés | Pavers Lapis

Système de couleurs pour marquage routier | Signage Colour System

Couleurs indestructibles à l'épreuve de la ville City-proof indestructible colours



Pavés Lapis Blanc et Noir
Pavers Lapis White and Black

Double chargement | Double-loaded

Pâte supérieure de couleur différente
Upper mixture of different colour

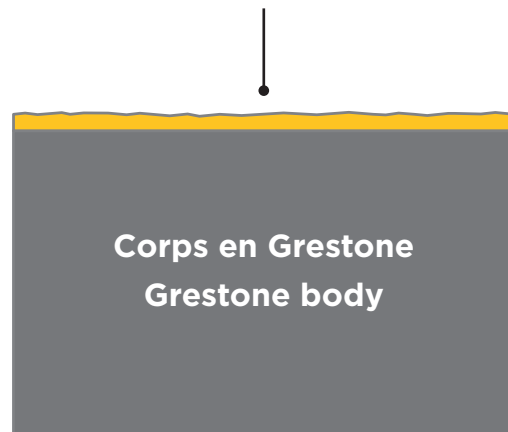

Dimensions disponibles | Available dimensions

Pavés Lapis Lux Gris et Noir
Pavers Lapis Lux Grey and Black

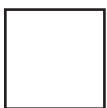

20 x 20 x 6,5 cm
8" x 8" x 2 1/2"



10 x 20 x 6,5 cm
4" x 8" x 2 1/2"

Pavés Lapis Lux Gris, Noir, Blanc, Jaune et Bleu
Pavers Lapis Lux Grey, Black, White, Yellow and Blue



10 x 10 x 6,5 cm
4" x 4" x 2 1/2"

Inspirations

Allées et stationnements | Driveways and Parking areas

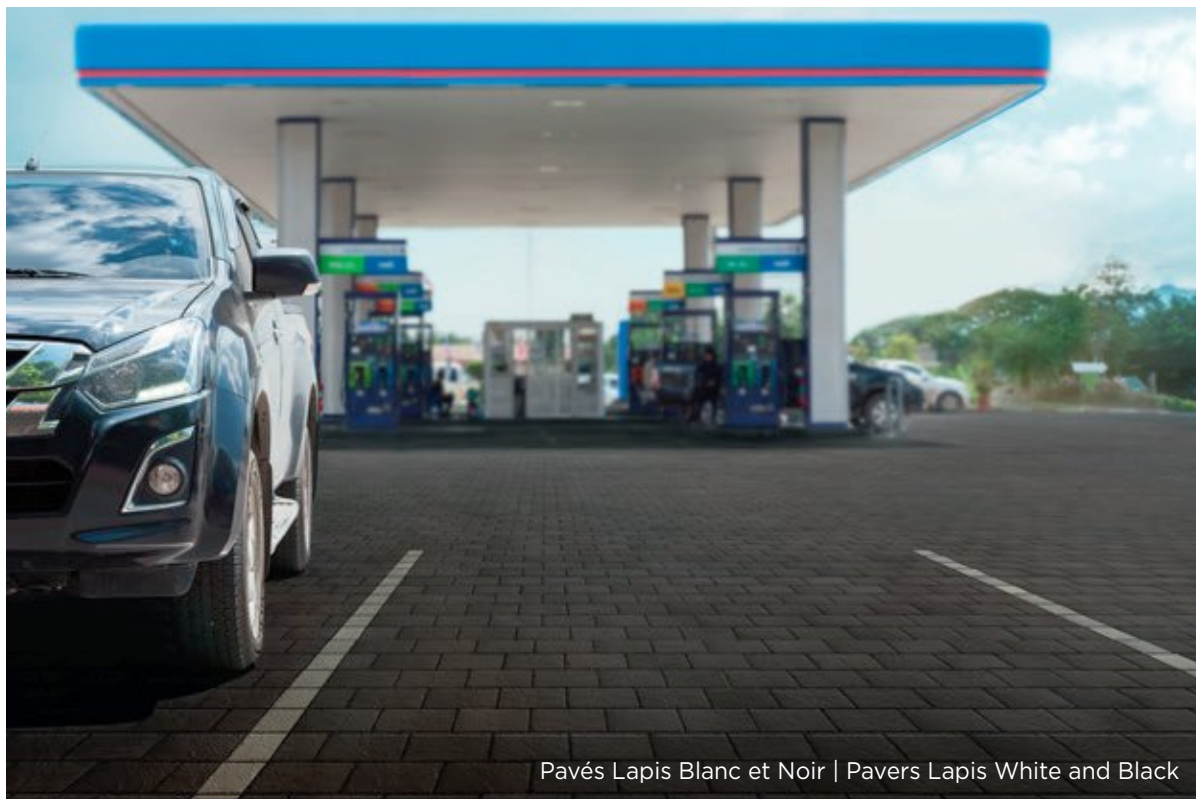

Pavés Lapis Blanc et Noir | Pavers Lapis White and Black



Pavés Lapis Lux Gris et Basalto naturale | Pavers Lapis Lux Grey and Basalto naturale

Inspirations

Espaces urbains | Urban spaces



Pavé Lapis Lux Gris | Paver Lapis Lux Grey



Pavé Lapis Lux Gris | Paver Lapis Lux Grey

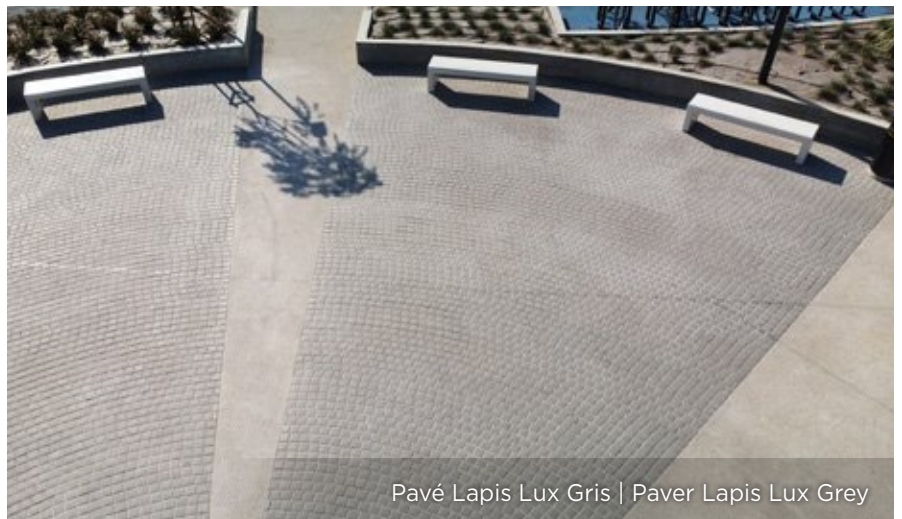

Pavé Lapis Lux Gris | Paver Lapis Lux Grey

Inspirations

Espaces urbains | Urban spaces



Pavés Pietra del Tirolo et Pietra Lavica Gris
Pavers Pietra del Tirolo and Pietra Lavica Grey



Pavés Pietra del Tirolo, Pietra Lavica Gris et Lapis Lux Gris
Pavers Pietra del Tirolo, Pietra Lavica Grey and Lapis Lux Grey

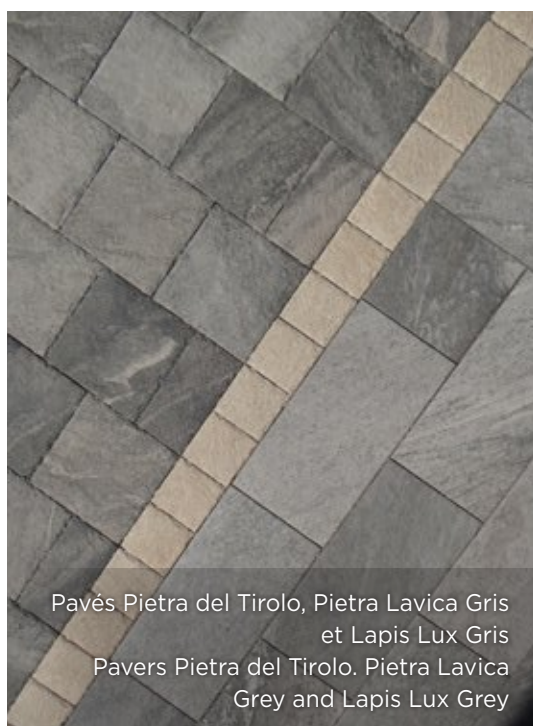

Pavés Pietra del Tirolo, Pietra Lavica Gris
et Lapis Lux Gris
Pavers Pietra del Tirolo, Pietra Lavica
Grey and Lapis Lux Grey

Inspirations

Espaces urbains | Urban spaces



Pavés Lapis Noir et Porfido rosso | Pavers Lapis Black and Porfido rosso

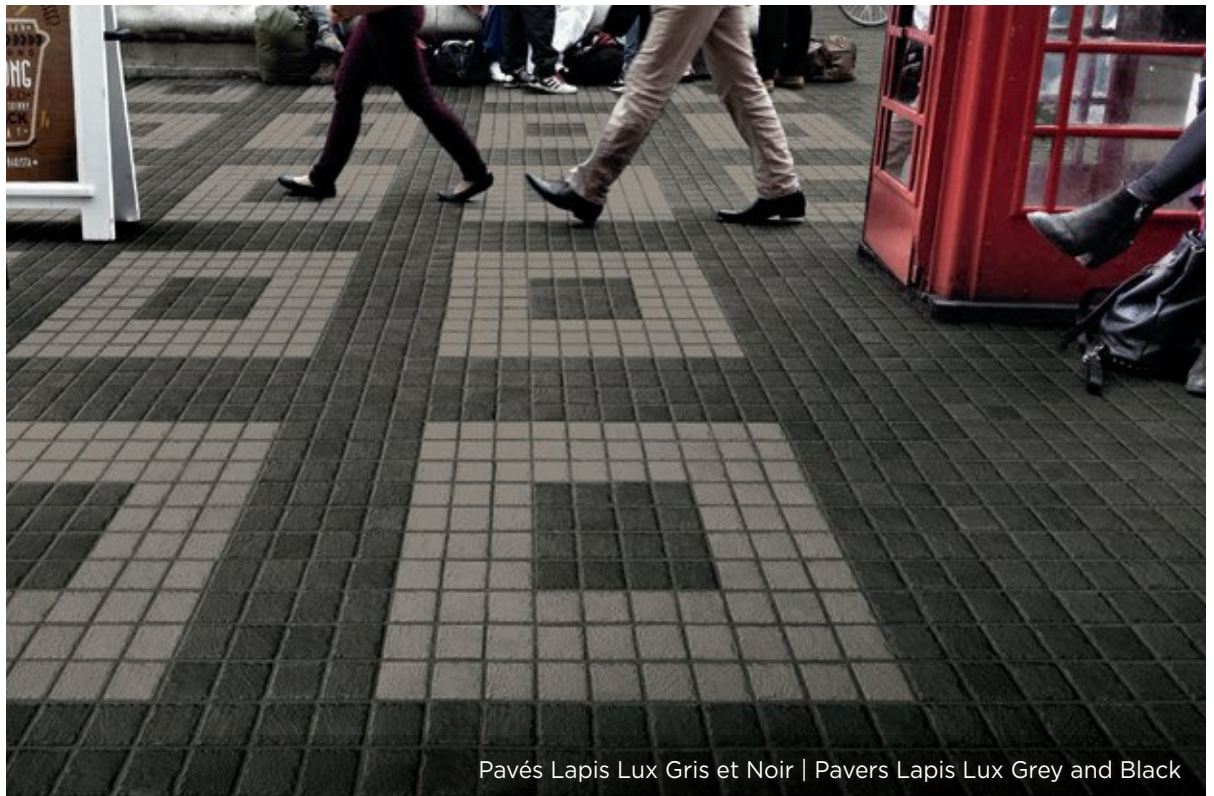

Pavés Lapis Lux Gris et Noir | Pavers Lapis Lux Grey and Black



eternoivica

eternoivica

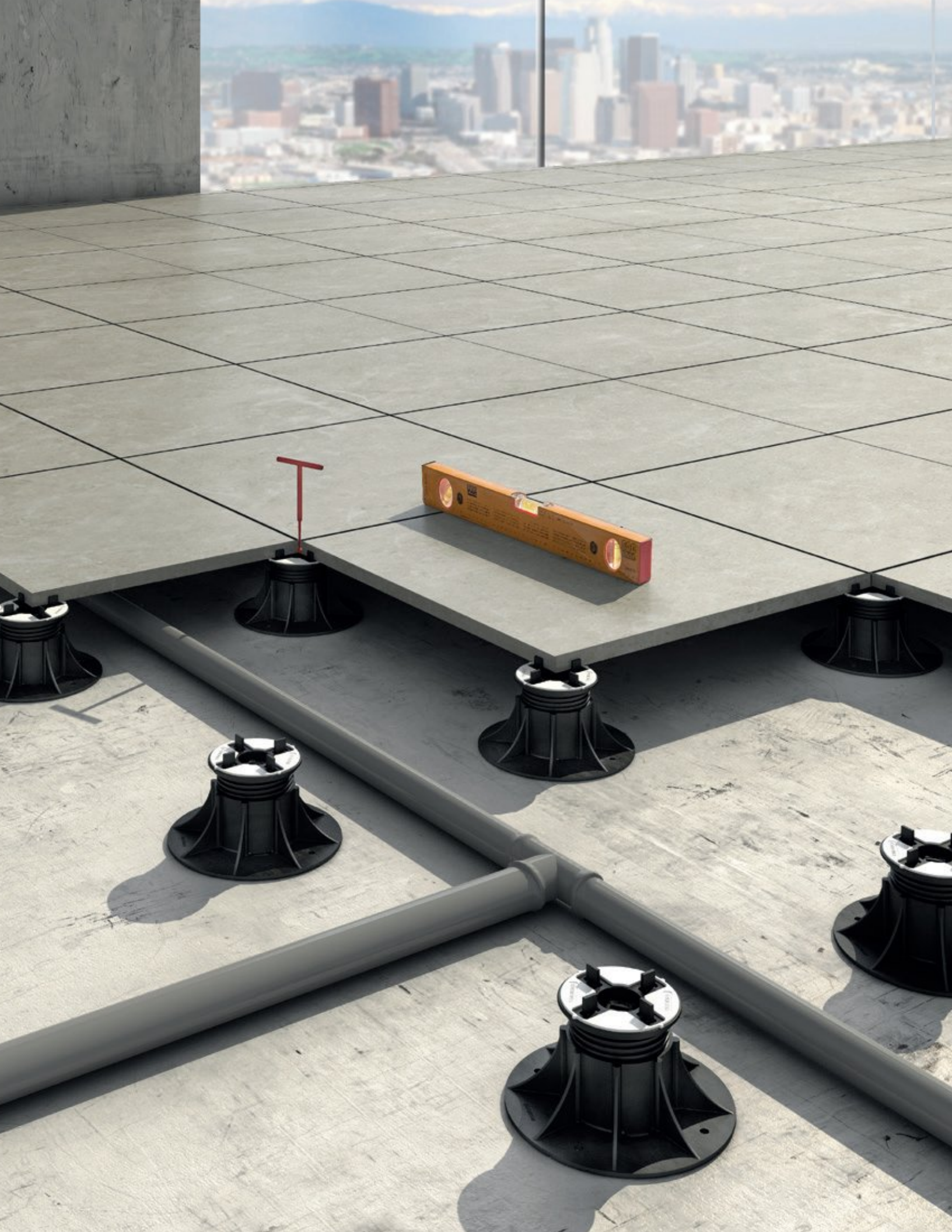

Les avantages du plancher surélevé

Advantages of raised floor



Forte résistance au poids
Strong weight resistance



Écoulement rapide de l'eau
Rapid outflow of water



Rapidité de pose
Speed of installation



Plancher toujours plat et de niveau
The floor is always flat



eterno ivica

Plots réglables | Adjustable supports

Les **plots réglables Eterno Ivica** offrent de multiples solutions pour compenser les petites imperfections et les grandes pentes de n'importe quel plan de pose, de façon à toujours réaliser des pavements parfaitement stables et à niveau. L'exclusive **clef de réglage**, élément essentiel du système, utilisable pour les plots **Pedestal Prime®**, **Eterno SE** et **New Maxi NM**, permet de régler les plots, et par conséquent le revêtement de sol au-dessus, même lorsque le pavement est terminé, en évitant ainsi de devoir le soulever. | The **Eterno Ivica adjustable height supports** offer multiple solutions to compensate for small imperfections and large gradients of any laying surface so as to always achieve very stable and perfectly flat floors. The unique **adjustment key**, using with **Pedestal Prime®**, **Eterno SE Support** and **New Maxi NM Support**, is an essential element of the system which allows the control of the paver supports (and consequently the floor above) even when the flooring has already been laid, without the need to lift any slab.





PR - Pedestal Prime® | Pedestal Prime® support

Description des composants | Components description

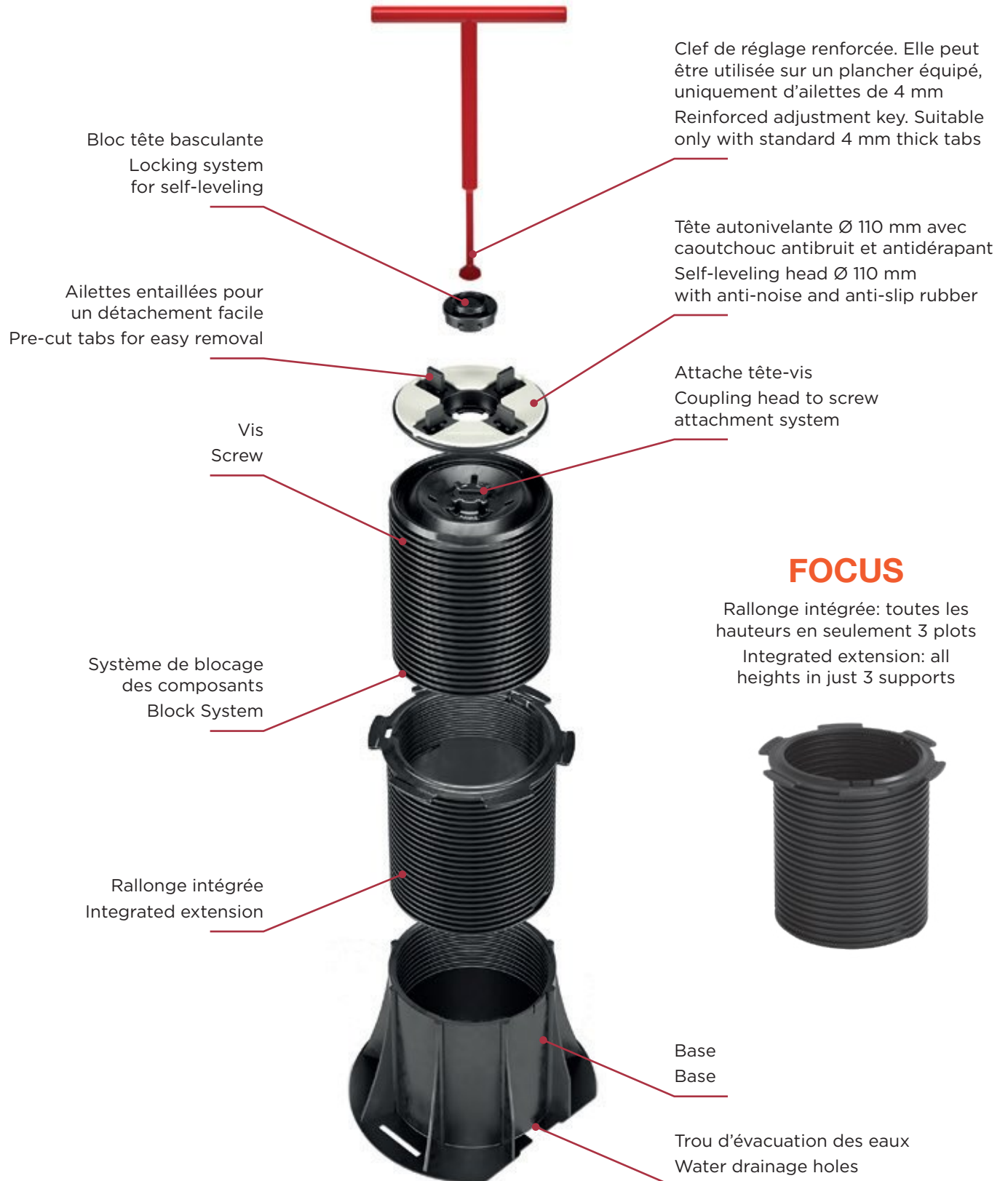



PR - Pedestal Prime® | Pedestal Prime® support

Rallonges intégrées | Integrated extensions



Rallonge PR
PR extension



Rallonge pour
grandes hauteurs
Extension for
great heights



30 - 65 mm
PR 1



65 - 155 mm
PR 2



155 - 420 mm
PR 3



310 mm



595 mm

PR 3 + 1 PR



410 mm



770 mm

PR 3 + 2 PR



515 mm



945 mm

PR 3 + 3 PR



SE - Plot Eterno | Eterno support

Description des composants | Components description

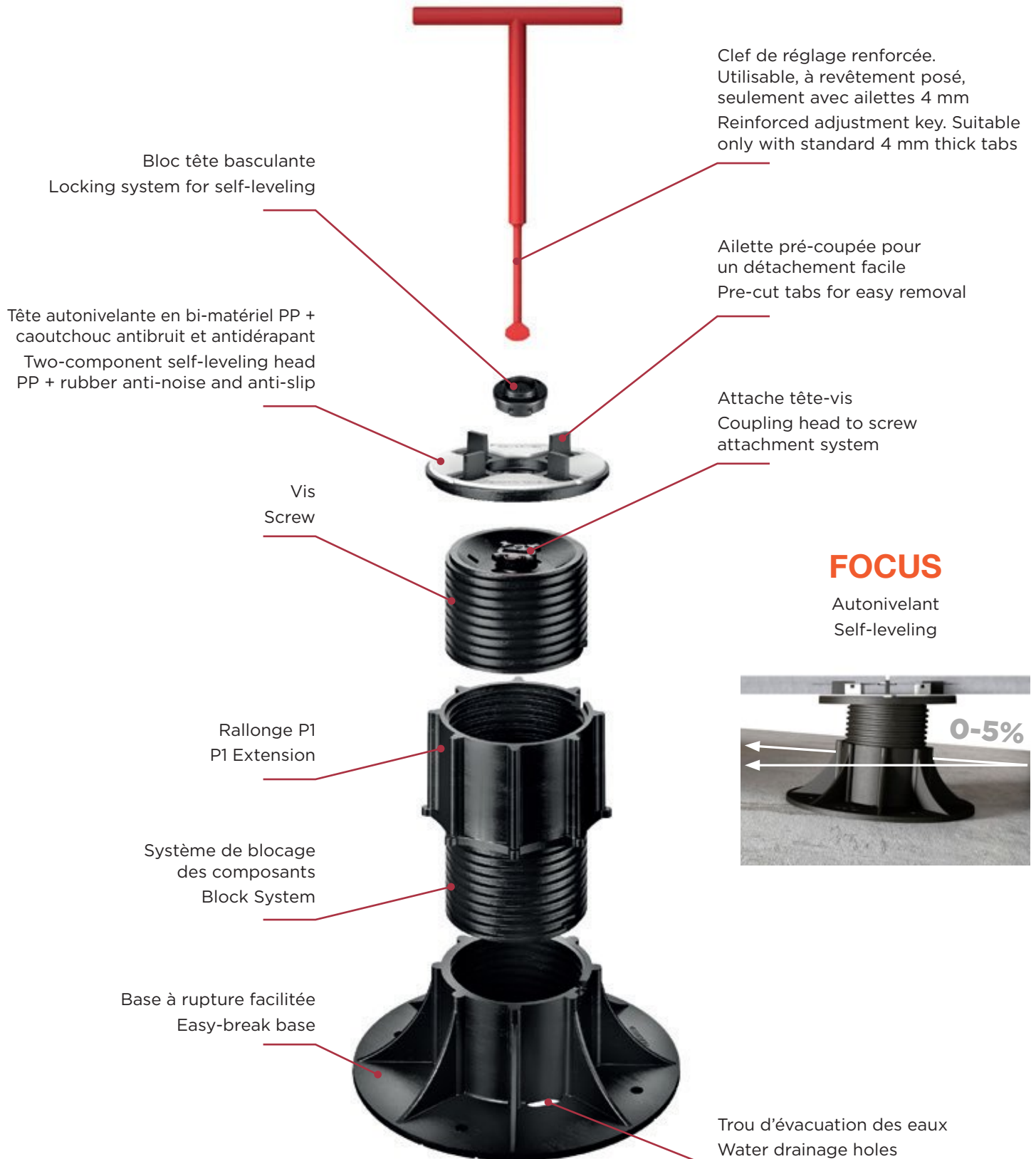



SE - Plot Eterno | Eterno support

Rallonges intégrées | Integrated extensions



Rallonge P1
P1 extension



SE 0 28-38 mm **SE 1** 37,5-50 mm **SE 2** 50-75 mm **SE 3** 75-120 mm **SE 4** 120-170 mm **SE 5** 170-215 mm **SE 6** 140-230 mm **SE 7** 185-275 mm



SE 8 235-325 mm **SE 9** 205-345 mm **SE 10** 250-385 mm **SE 11** 300-400 mm **SE 12** 270-455 mm **SE 13** 315-500 mm **SE 14** 365-550 mm



NM - Plot New Maxi | New Maxi support

Description des composants | Components description

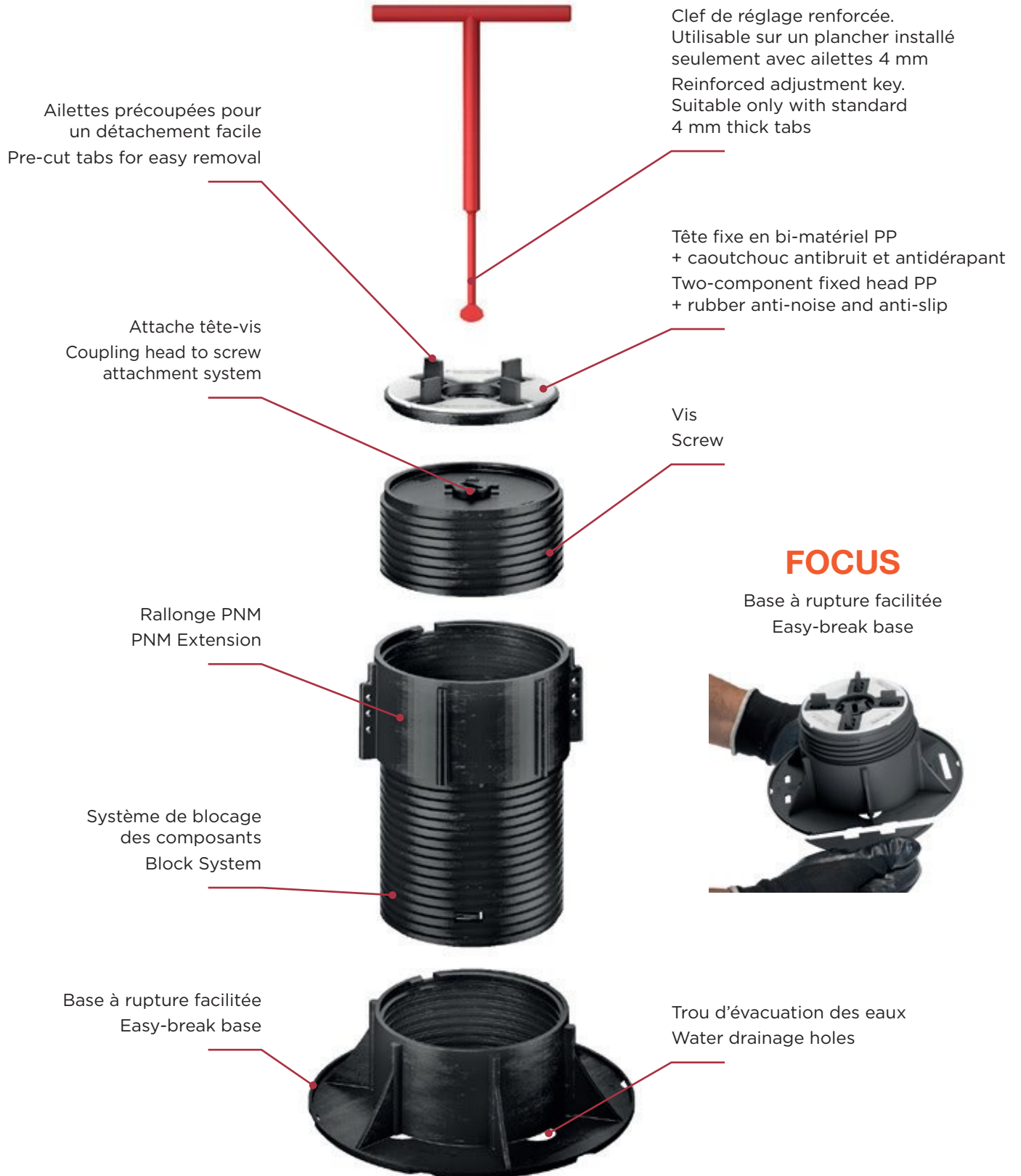



NM - Plot New Maxi | New Maxi support

Rallonges intégrées | Integrated extensions



Rallonge PNM
PNM Extension



NM 1
25-40 mm



NM 2
40-70 mm



NM 3
60-100 mm



NM 4
90-160 mm



NM 5
150-270 mm



NM 3 + 2 PNM
275-395 mm



NM 3 + 3 PNM
380-540 mm



NM 4 + 1 PNM
195-305 mm



NM 4 + 2 PNM
305-450 mm



NM 4 + 3 PNM
410-590 mm



NM 5 + 1 PNM
300-415 mm



NM 5 + 2 PNM
410-555 mm



NM 5 + 3 PNM
520-700 mm



ST - Plot réglable Star.T | Star.T support

Description des composants | Components description



Plot Star.T
Star.T support

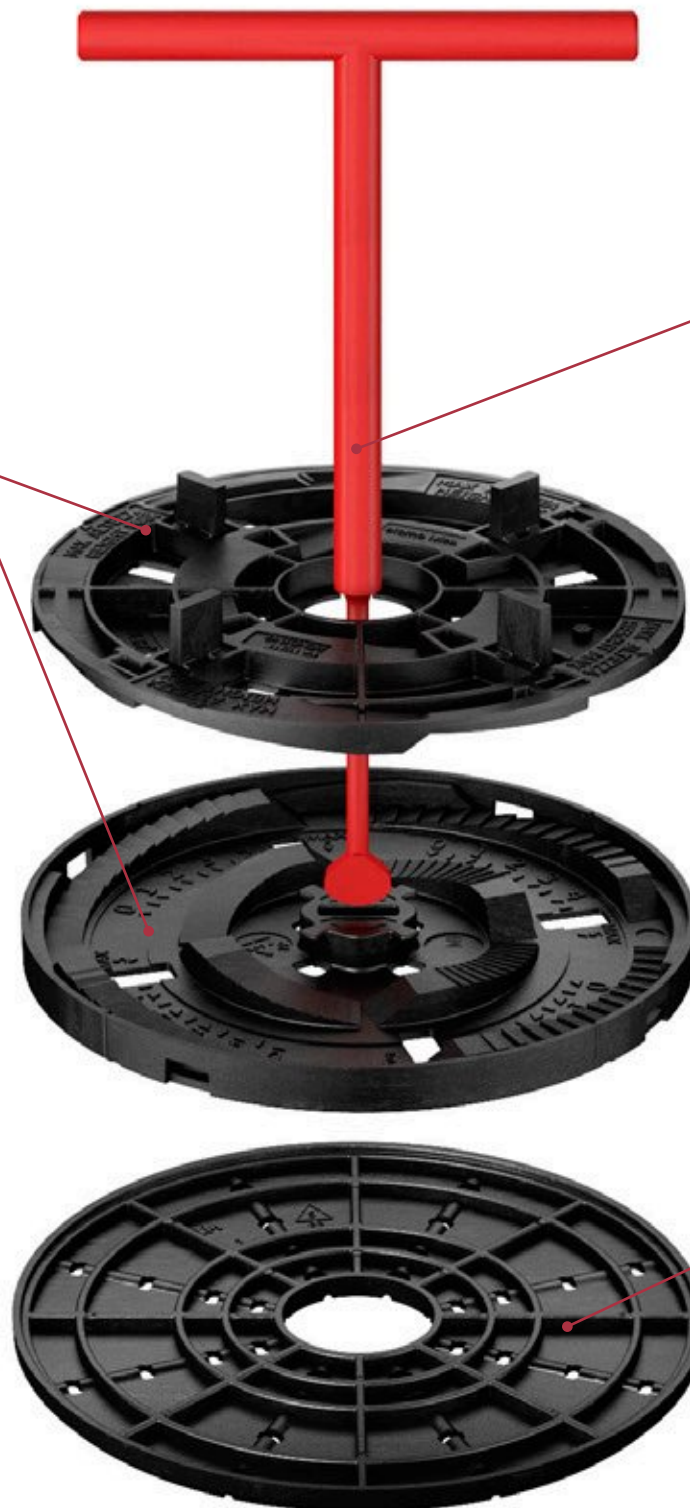

Clef de réglage
(NOTE : l'emploi de la clef
est possible jusqu'à un
maximum de 2 dalles)
Adjustment key
(NOTE: the use of the key
is only possible up to a
maximum of 2 slabs)



Rallonge Star.T
Star.T extension



ST - Plot réglable Star.T | Star.T support

Emploi des composants Star.T

Possible uses of Star.T components

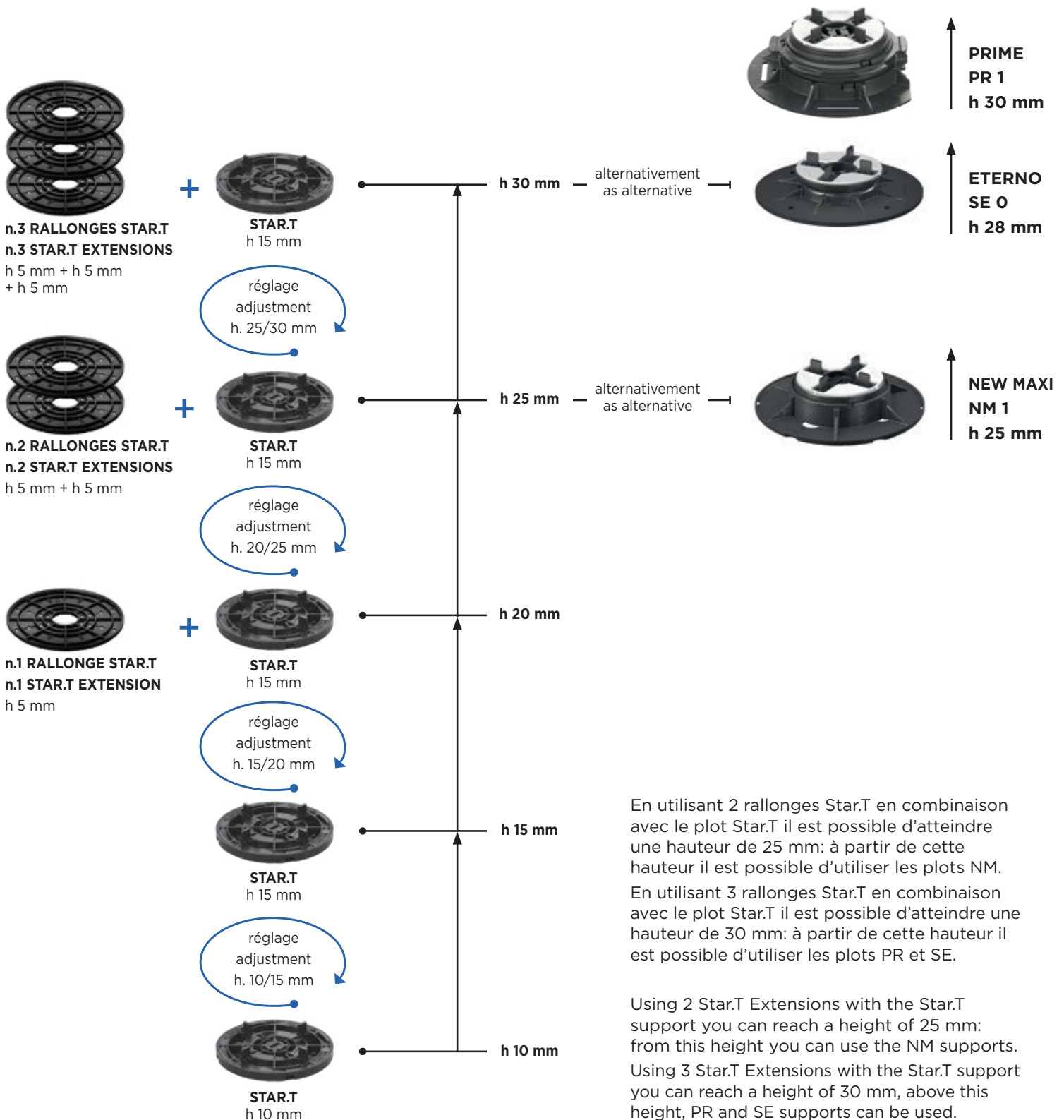

En utilisant 2 rallonges Star.T en combinaison avec le plot Star.T il est possible d'atteindre une hauteur de 25 mm: à partir de cette hauteur il est possible d'utiliser les plots NM. En utilisant 3 rallonges Star.T en combinaison avec le plot Star.T il est possible d'atteindre une hauteur de 30 mm: à partir de cette hauteur il est possible d'utiliser les plots PR et SE.

Using 2 Star.T Extensions with the Star.T support you can reach a height of 25 mm: from this height you can use the NM supports. Using 3 Star.T Extensions with the Star.T support you can reach a height of 30 mm, above this height, PR and SE supports can be used.



SB - Plot réglable Basic | Basic adjustable support

Description des composants | Components description

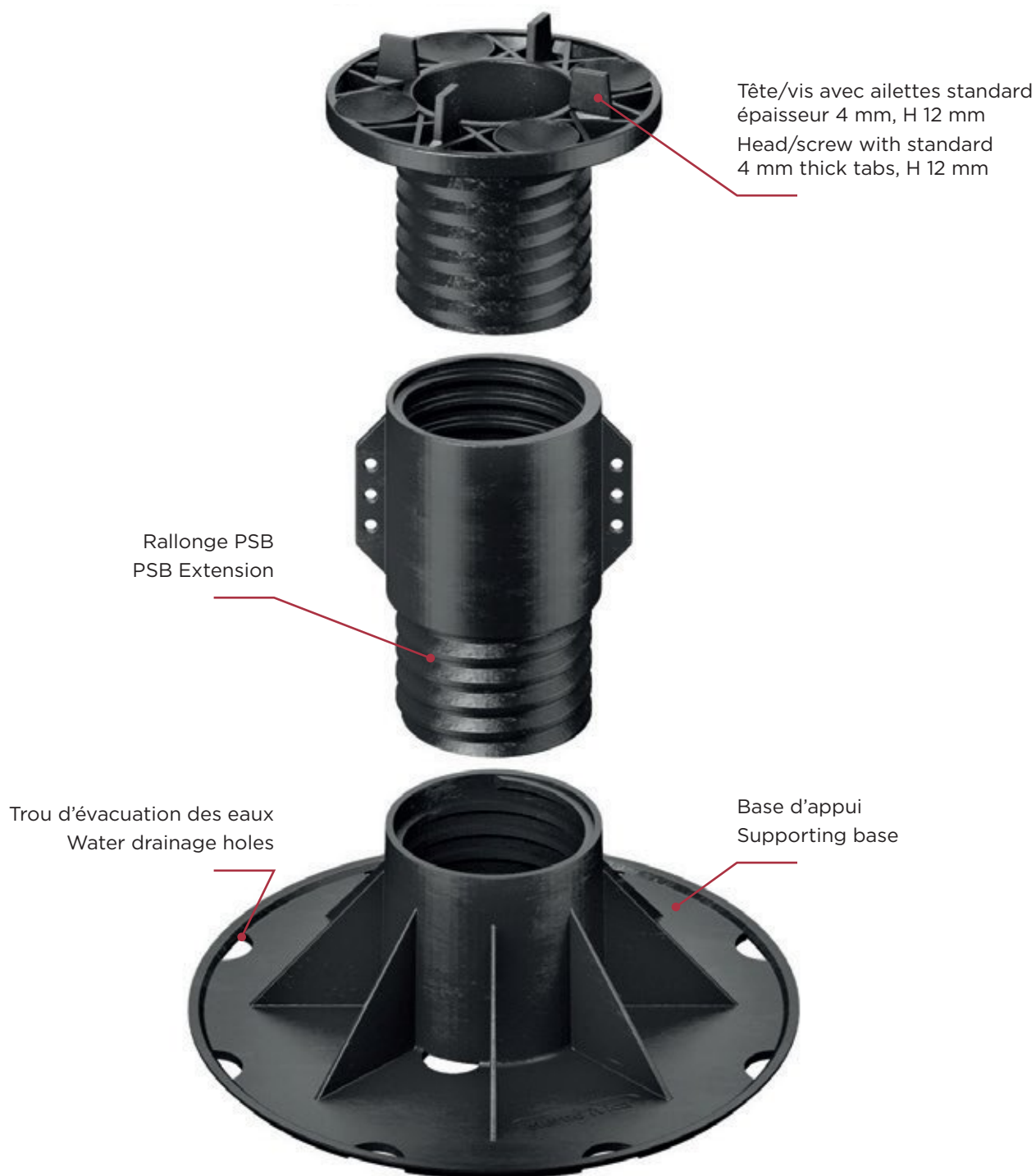



SB - Plot réglable Basic | Basic adjustable support

Rallonges intégrées | Integrated extensions



Rallonge PSB
PSB Extension



SB 1
27-35 mm



SB 2
35-50 mm



SB 3
50-80 mm



SB 4
70-120 mm



SB 5
112-168 mm



SB 6
132-210 mm



SB 7
175-260 mm



SB 8
195-300 mm



GRF System | Grilles de sécurité

Description des composants | Components description

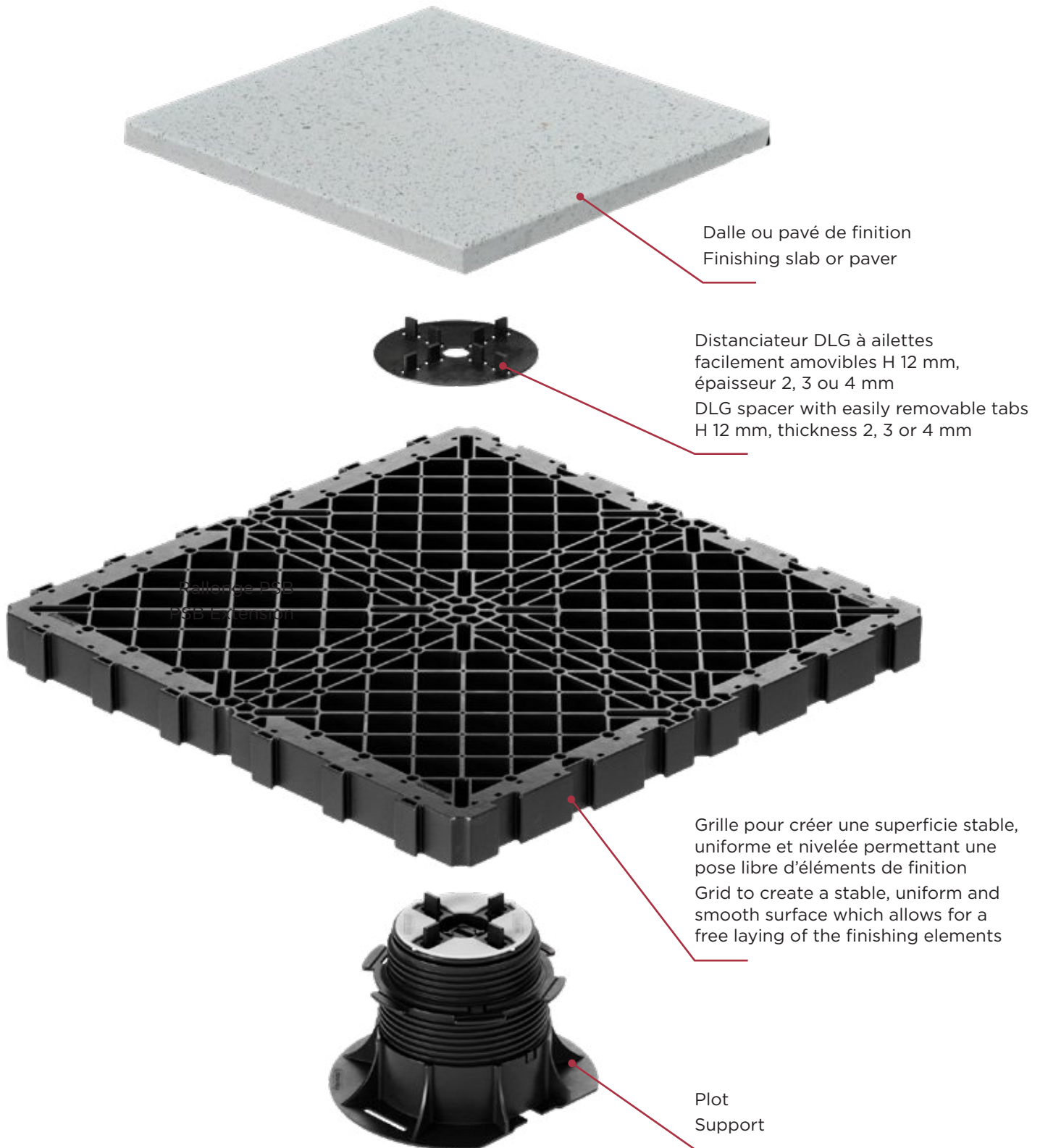

Inspirations

Cour intérieure d'un hôpital Interior courtyard of a hospital

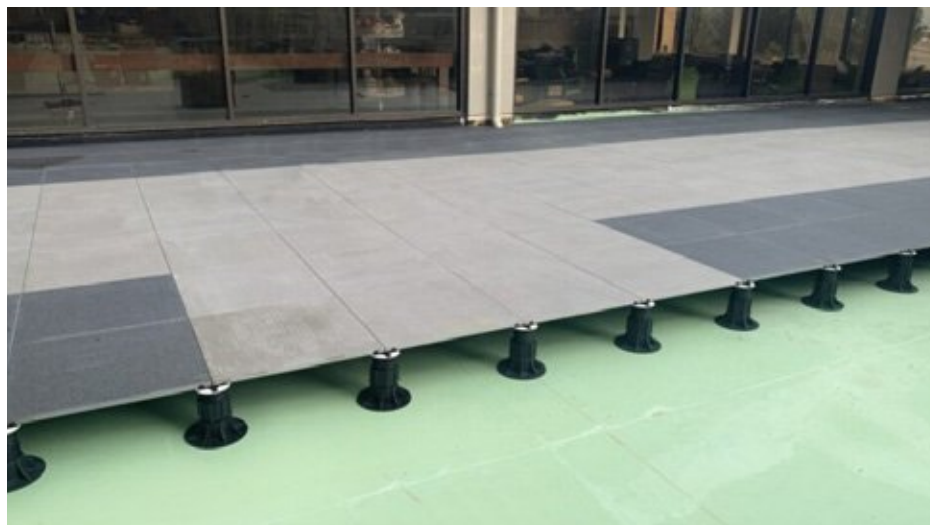

Inspirations

Cour intérieure d'un hôpital

Interior courtyard of a hospital





EH Rubber 10+6



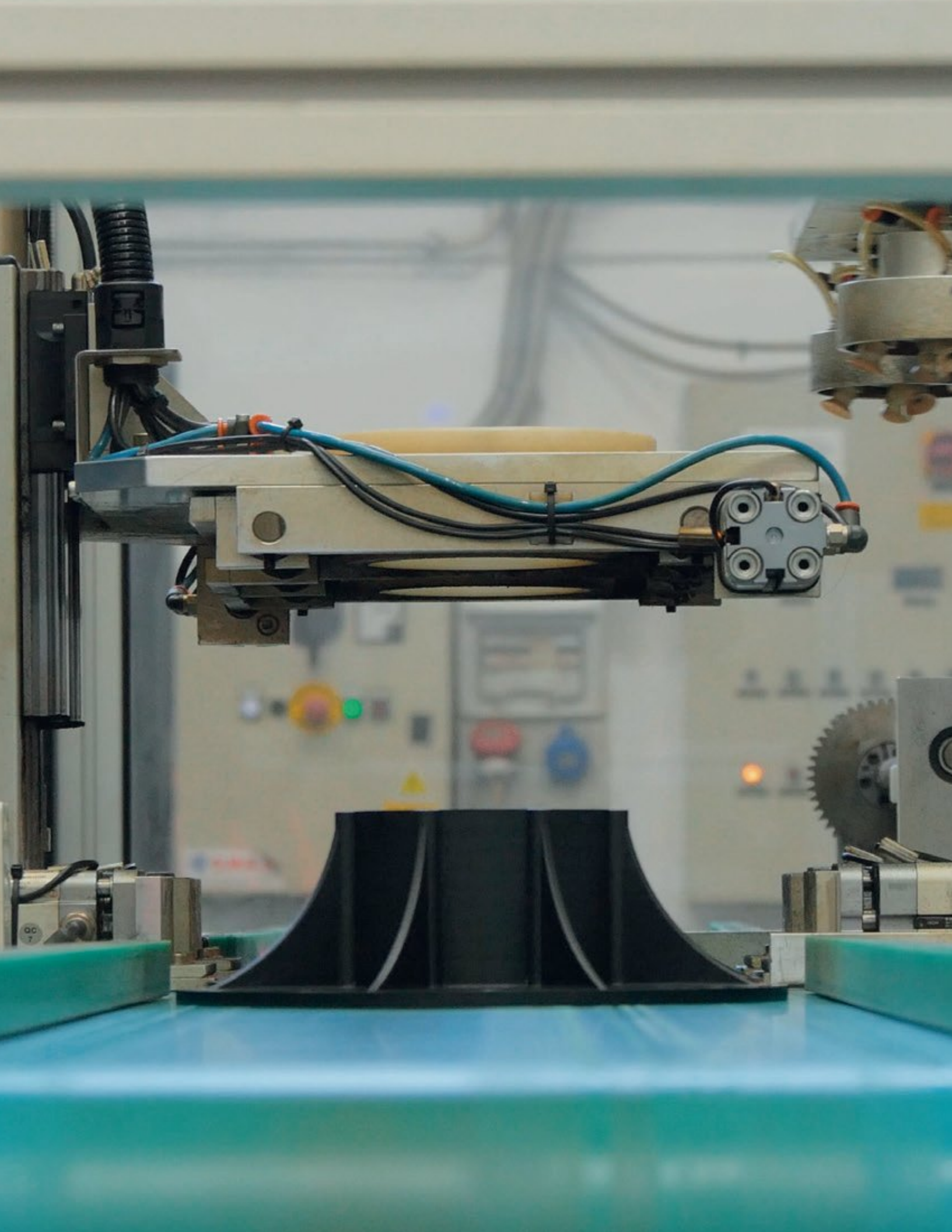

Plots spéciaux | Special supports

Après de nombreuses années d'expérience dans le domaine des plots pour **planchers surélevés extérieurs**, Eterno Ivica, toujours attentive au développement du marché et aux exigences de la clientèle, a réalisé une ligne de **plots spéciaux** expressément conçus pour de particulières nécessités. C'est ainsi que sont nés les **plots de la ligne Anti-vent PR W, SE W et NM W** ainsi que les **plots métalliques SMA et SMAT**. | After years of experience in the field of **raised floors for outdoor floors**, Eterno Ivica, always attentive to market development and customer needs, has created a line of **special supports** designed specifically for special needs. This is how the supports of the **Windproof line** were born, **PR W, SE W and NM W** as well as **SMA and SMAT metal supports**.

PR W



NM W



SE W



SMAT



SMA



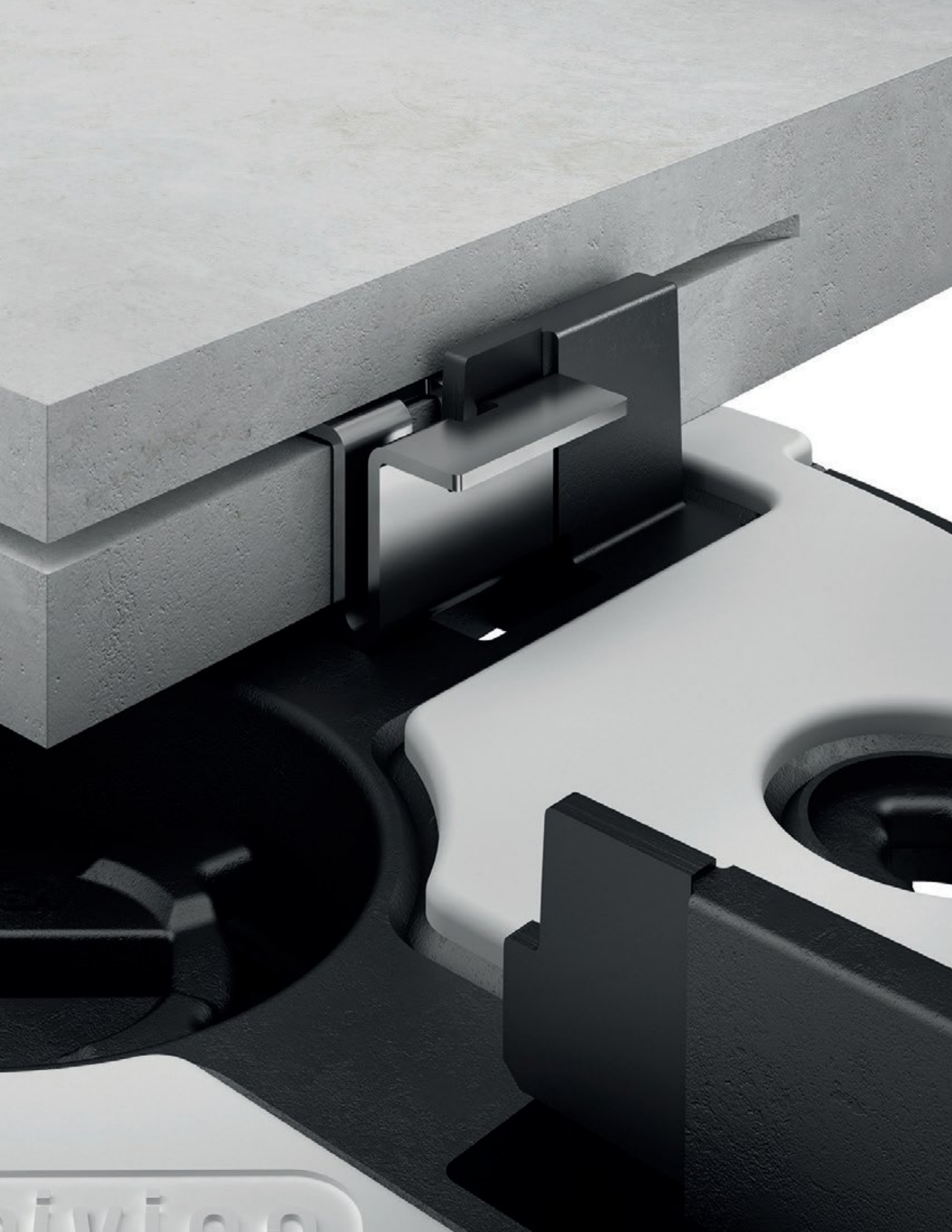

Plots Anti-Vents PR W, SE W et NM W

Windproof pedestals PR W, SE W and NM W

Description des composants | Components description

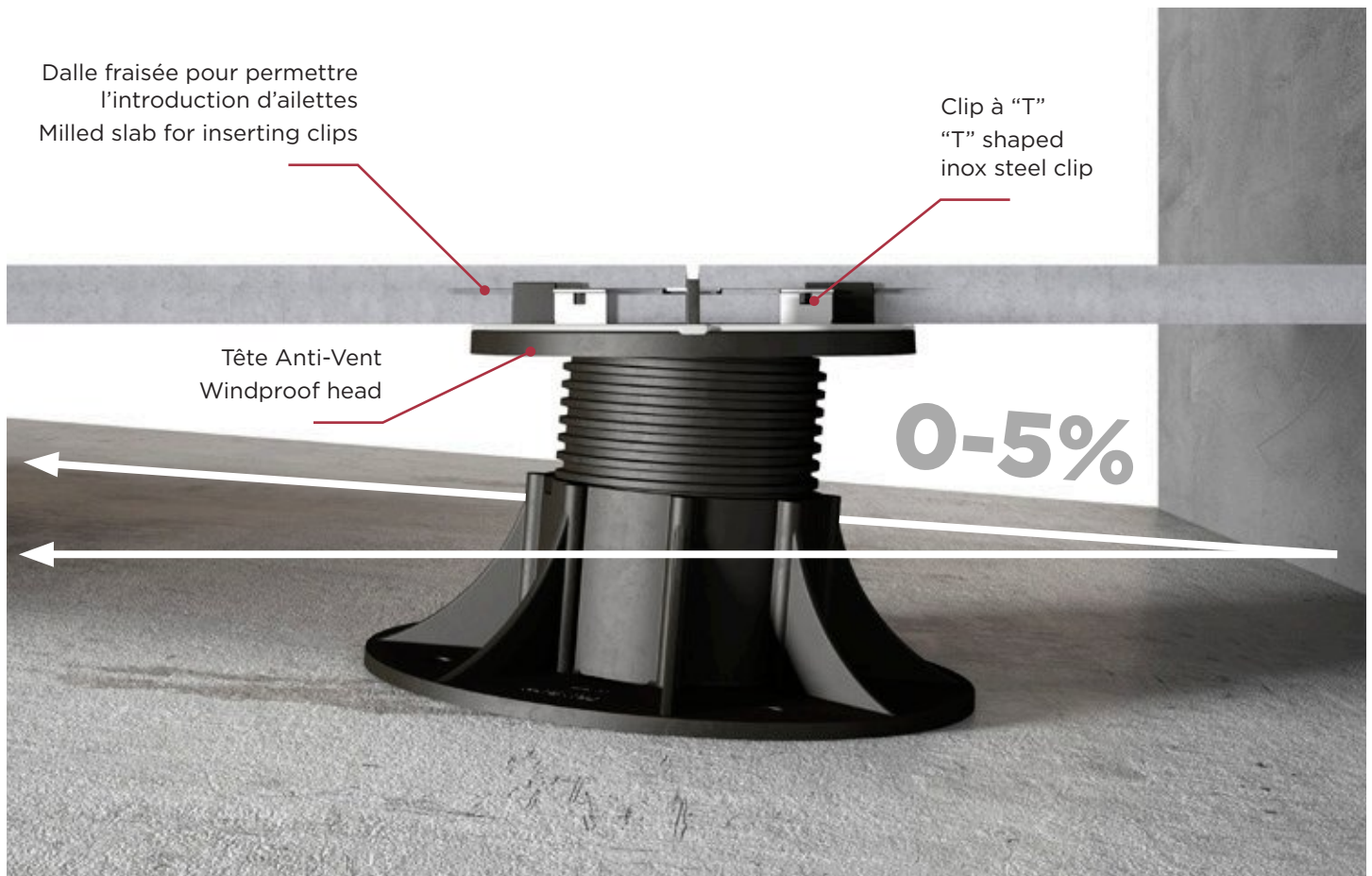

Tête Anti-Vent | Windproof head



Clip à "L"
"L" shaped clip

Clip à "T"
"T" shaped clip



SMA - Plot métallique à tête autonivelante à ailettes pour dalles | Metal support with self-leveling head with tabs for slabs

Description des composants | Components description

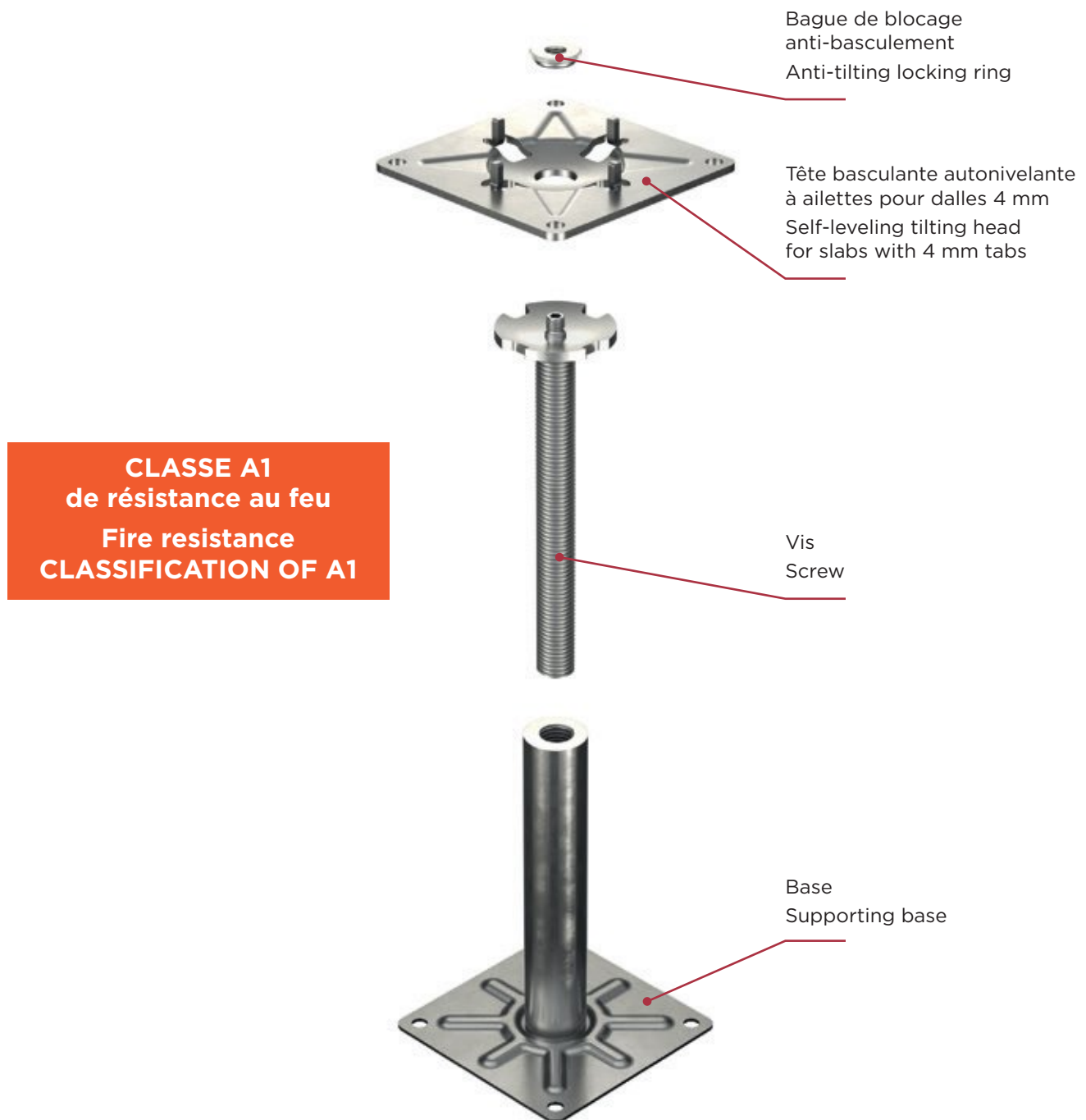



SMAT - Plot métallique à tête autonivelante pour lambourde en aluminium | Metal support with self-leveling head for aluminium joist

Description des composants | Components description

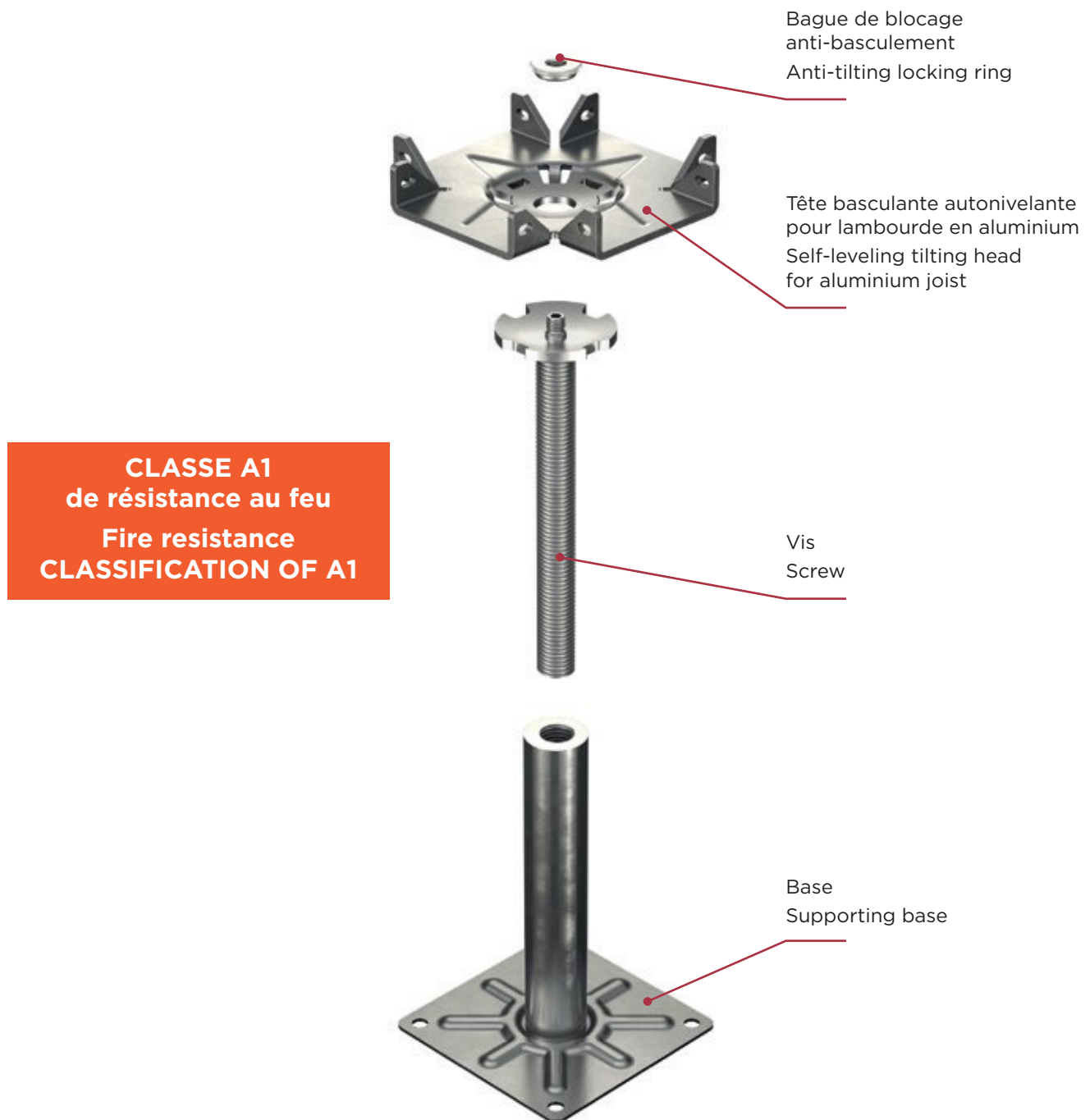

Accessoires | Accessories





CE 614
10
sternolivo



MLT™ **MECHANICAL LIPPAGE TUNING** SYSTEM



Outils professionnels de nivelage

Professional leveling tools

Les essentiels (séries Slim et Ready)

The basics (Slim and Ready lines)

Base universelle | Universal cap



Optionnels | Optionals

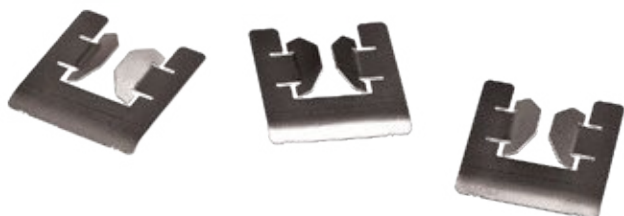

Insertion métallique | Metal insert



Base en caoutchouc | Rubber foot



Outils professionnels de nivelage

Professional leveling tools

Les straps (série Slim) | Straps (Slim line)



Strap T1
(épaisseur standard jusqu'à 1,9 mm)

Strap T1
(thickness up to 1.9 mm)

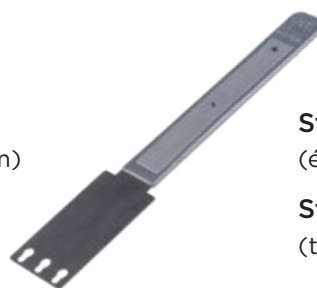

Strap T3-M
(épaisseur de 20 à 30 mm)

Strap T3-M
(thickness from 20 to 30 mm)

Les straps (série Ready) | Straps (Ready line)



Strap TP-0.8
(usage unique pour joint de coulis de 0,8 à 1,2 mm)

Strap TP-0.8
(single-use for grout joints from 0.8 to 1.2 mm)



Strap TP-1.2
(usage unique pour joint de coulis de 1,2 à 2,0 mm)

Strap TP-1.2
(single-use for grout joints from 1.2 to 2.0 mm)

Outils professionnels de nivelage Professional leveling tools

Les plaques inférieures (série Slim) | Bottom plates (Slim line)

*Compatible qu'avec les straps de la série Slim | Compatible only with Slim line straps



Plaque inférieure P1
(pour les tuiles ultraminces)

Bottom plate P1
(for ultra-thin tiles)

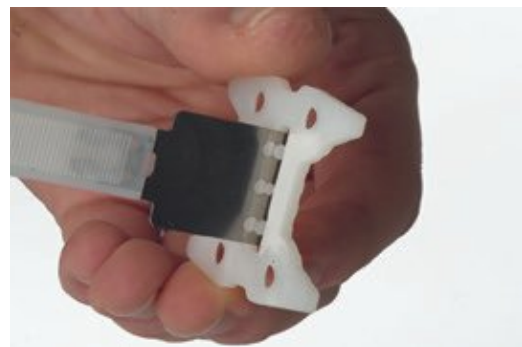

Plaque inférieure P2
(pour les tuiles de
porcelaine standard)

Bottom plate P2
(for standard porcelain tiles)



Plaque inférieure P3
(pour pierres et marbres)

Bottom plate P3
(for stones and marbles)

Outil de réglage (séries Slim et Ready) Setting tool (Slim and Ready lines)



Outil de réglage ergonomique MAP-01
Ergonomic setting tool MAP-01



Outils professionnels de nivelage

Professional leveling tools

Les ensembles (série Slim) | Kits (Slim line)



Ensemble 100S-P1

Inclus :

- 100 bases universelles
- 100 straps T1
- 1 outil de réglage ergonomique MAP-01
- 250 plaques inférieures P1

Kit 100S-P1

Contains:

- 100 universal caps
- 100 straps T1
- 1 ergonomic setting tool MAP-01
- 250 bottom plates P1

Ensemble 100S-P2

Inclus :

- 100 bases universelles
- 100 straps T1
- 1 outil de réglage ergonomique MAP-01
- 250 plaques inférieures P2

Kit 100S-P2

Contains:

- 100 universal caps
- 100 straps T1
- 1 ergonomic setting tool MAP-01
- 250 bottom plates P2

Ensemble 100S-P3

Inclus :

- 100 bases universelles
- 100 straps T1
- 1 outil de réglage ergonomique MAP-01
- 250 plaques inférieures P3

Kit 100S-P3

Contains:

- 100 universal caps
- 100 straps T1
- 1 ergonomic setting tool MAP-01
- 250 bottom plates P3

Outils professionnels de nivelage

Professional leveling tools

Les ensembles (série Ready) | Kits (Ready line)



Ensemble 100R-1

Inclus :

- 100 bases universelles
- 100 straps TP-0.8
- 1 outil de réglage ergonomique MAP-01

Kit 100R-1

Contains:

- 100 universal caps
- 100 straps TP-0.8
- 1 ergonomic setting tool MAP-01

Ensemble 100R-2

Inclus :

- 100 bases universelles
- 100 straps TP-1.2
- 1 outil de réglage ergonomique MAP-01

Kit 100R-2

Contains:

- 100 universal caps
- 100 straps TP-1.2
- 1 ergonomic setting tool MAP-01



ALPHA[®]

Outils professionnels de sciage de porcelaine

Professional porcelain cutting tools

Lames mouillées/sèches | Wet/Dry Blades



BladeMaster 14" (trou 1") tout usage
BladeMaster 14" (1" hole) all-purpose



MasonMaster 14" pour le béton
MasonMaster 14" for concrete



PT Cutter 9" pour la porcelaine
PT Cutter 9" for porcelain



Ultracut GPM 7" pour la porcelaine
Ultracut GPM 7" for porcelain

Outils professionnels de sciage de porcelaine

Professional porcelain cutting tools

Lames sèches | Dry Blades



PT Cutter 14" pour la porcelaine
PT Cutter 14" for porcelain



PT Cutter 12" pour la porcelaine
PT Cutter 12" for porcelain



Katana 5" pour la porcelaine
Katana 5" for porcelain



LES PRODUITS

GREFINO

PRODUCTS

Nous innovons votre espace extérieur.

We Innovate your Outdoor space.

Catalogue 2024

